



Planning Guide for Escalators and Moving Walks

The Best Solution Requires Step-By-Step
Preparation





Table of Contents

Introduction	4
Why Escalators and Moving Walks Matter	5
- Commercial Sector	
- Public Sector	
- Escalators, Moving Walks, and Elevators	
Basic Planning	7
- Positioning Escalators or Moving Walks Within a Building	
- Escalators or Moving Walks?	
- How Many Escalators or Moving Walks?	
- Arrangement of Escalators and Moving Walks	
- Proper Inclination	
- Optimal Step/Pallet Widths	
- Optimal Speed	
Detailed Planning	14
- Standards	
- Transportation of Disabled Persons, Transportation of Baby Carriages	
- Space Requirement	
- Safety, Regulation-Compliant	
- Operating Modes	
- Special Applications	
The Best Product for Your Premises	21
Services Provided by the Customer, Site Preparations	23
- Moving the Escalator or Moving Walk Into the Building	
- Transportation to the Installation Site	
- Delivery Modes	
- Suspension Points to be Provided by the Customer	
- Connections to Other Installations	
From Production Release to Final Installation	27
- Production Release	
- Site Preparation Inspection	
- Transportation From Factory to Site	
- Moving the Escalator/Moving Walk Into the Building	
- Setting Down Onto the End Supports	
- Final Installation, Commissioning	
Interactive Configuration With SchindlerDraw	30
Key Points for the Planning Process (Checklist)	31

Introduction

No invention has had more of an influence on shopping than the escalator. Over the past 100 years, the escalator has opened up a whole new world as a simple means of connecting different floors, a world we now move around in as a matter of course.

The escalator was the most radical element in this architectural change process, and even today it is still the most popular installation in our retail environment – even if it is the one least perceived by its users.

Escalators and moving walks still play a key role in transporting large numbers of people. Planning escalators and moving walks correctly in shopping centers, trade fair centers, stores, movie theaters, and public transportation facilities is essential for business success and the smooth flow of people. This brochure is your universal guide to all the main process stages, from project planning to commissioning.

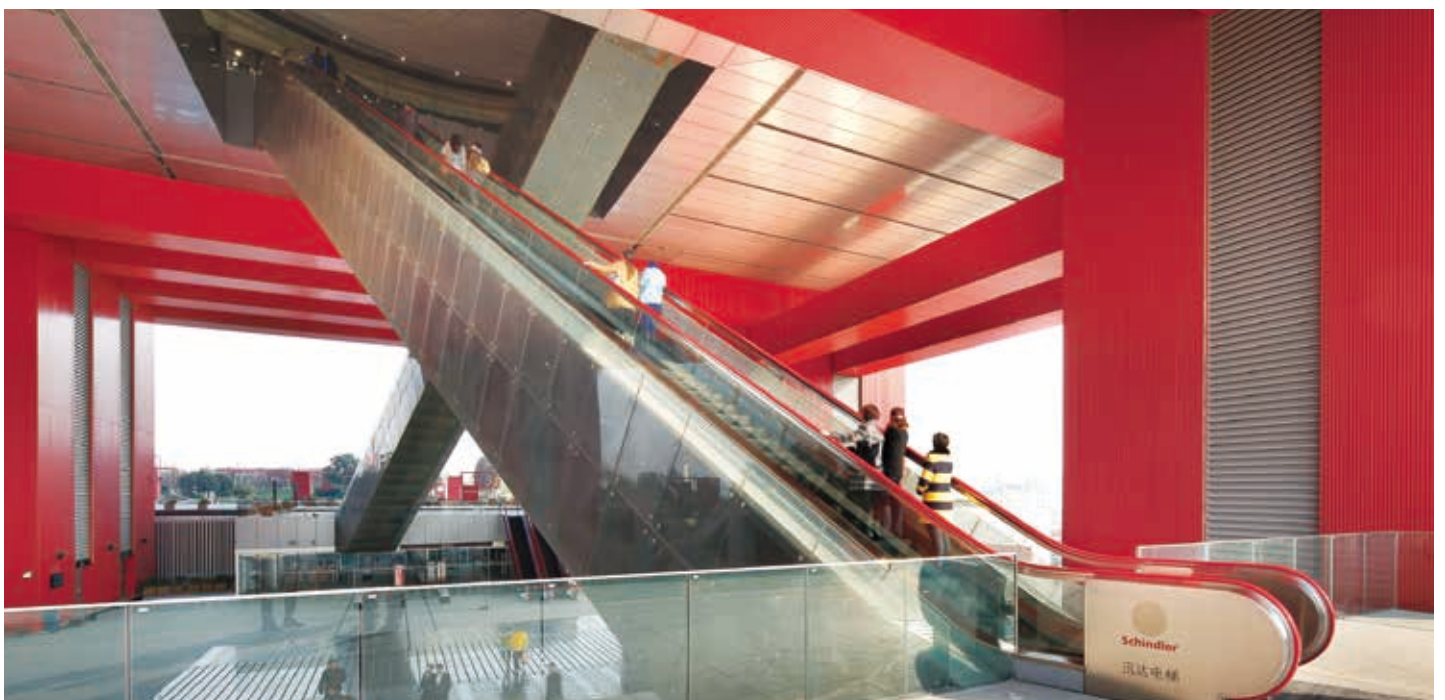

Why Escalators and Moving Walks Matter

Commercial Sector

Escalators and moving walks are used to increase customer density and thus help boost sales in buildings used for commercial purposes. The following examples taken from everyday practice clearly illustrate how and why:

Example 1: Department Store

A six-story department store in the center of a European capital had three elevator units operated by a single control system. The objective here was to boost sales on the upper floors by 20 percent by increasing customer flow.

At the planners' recommendation, the owner opted to install escalators. As a result, customer flow was substantially increased and sales rose by more than 30 percent.

Example 2: Food Store

A retailer provided access to the upper floor of his store using two comfortable and attractively designed glass elevators. Moving walks had not

been installed for space reasons. Even after the elevators had been in operation for some time, the scheduled sales figures on the upper floor were not achieved due to insufficient customer flow. Once moving walks were installed, sales increased several-fold.

Example 3: Underground Parking Garage

A centrally located department store with a food hall and a multi-story underground parking garage was unable to achieve its targeted turnover objectives in the food hall. Internal analyses showed that elevator access as a whole was insufficient. Using moving walks to provide access to all underground levels solved the problem as customers were able to get to their cars directly with their shopping carts. The sizable investment into the retrofit installation was justified by the increase in sales.

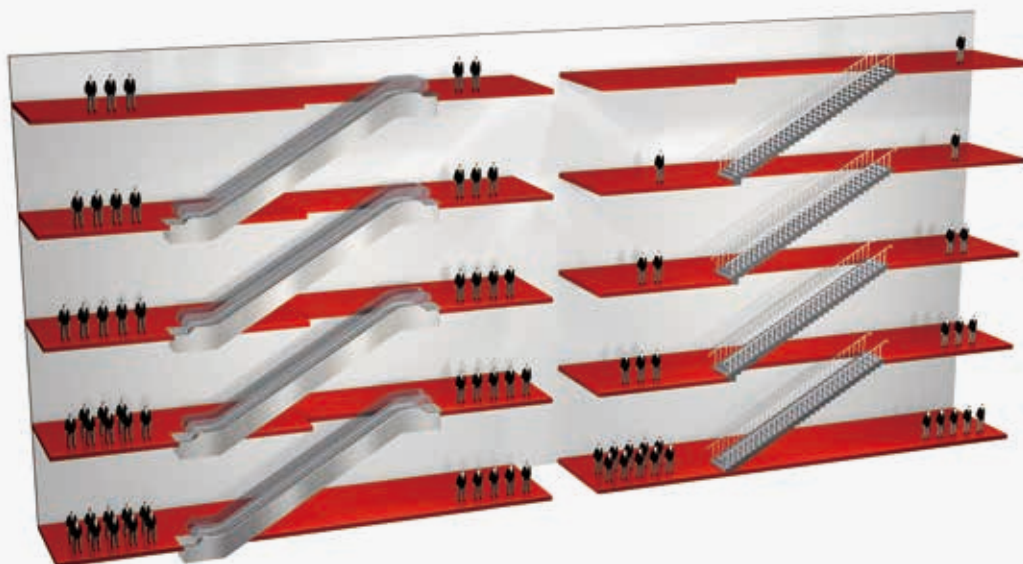

Escalators can help increase sales on all shopping levels

Ordinary stairways limit customer frequency on the upper floors

Why Escalators and Moving Walks Matter

Public Sector

Transporting large numbers of people efficiently is the top priority in public transportation. Schindler offers customized solutions for this area of application. Our escalator experts can tell you all about the special configuration options.

Escalators, Moving Walks, and Elevators

In the commercial sector, escalators and moving walks as well as elevators ensure a smooth traffic flow. Our experts will suggest the right choice and combination to suit your specific requirements.

Advantages of escalators and moving walks:

- Escalators and moving walks with a moving step/pallet band look inviting
- Escalators and moving walks help channel passenger flow
- Escalators and moving walks have a high transportation capacity
- Escalators and moving walks are open and convey people continuously
- Escalators and moving walks ensure that all floors are frequented evenly



Basic Planning

Positioning Escalators or Moving Walks Within a Building

Basically, to achieve optimal customer density, the movement of customers within the building has to be facilitated. Distances in excess of 50 meters should be avoided on commercial premises and in office buildings. The charts below show basic escalator arrangements.

Customer circulation on sales premises depends on different criteria, such as the layout of the goods on sale. Fast-selling goods are usually sold in areas that are farther away from escalators. We recommend working closely with specialized store fitters or planners.

Escalators or Moving Walks?

Moving walks should be provided as a matter of principle whenever shopping or baggage carts are to be transported.

How Many Escalators or Moving Walks?

To determine the transportation requirements (persons per hour), you need to consider the following parameters:

- Type of building (offices, shopping center, movie theater, subway station, airport; one-way traffic, two-way traffic; single- or multi-purpose building)
- Peak traffic times (office opening and closing hours)
- Population factor based on net usable area
- Customer turnover rate per floor in department stores
- Level of traveling comfort required on the unit (uncrowded, convenient, crowded)

Basic Planning

Once the transportation requirements have been stipulated, you can determine the number of escalators or moving walks required. Our experts will be happy to advise you.

The theoretical transportation capacity depends on the width and speed of the escalators. The effective transportation capacity is between 40 and 80 percent of the theoretical transportation capacity depending on user density and step width. The capacity of moving walks is calculated accordingly, taking into account transportation of shopping and baggage carts.

Arrangement of Escalators and Moving Walks

Single Unit

The single unit is used to connect two levels. It is suitable for buildings with passenger traffic flowing mainly in one direction. Flexible adjustment to traffic flow (e.g., up in the morning and down in the evening) is possible.

Continuous Arrangement (One-Way Traffic)

This arrangement is used mainly in smaller department stores to link three sales levels. It requires more space than the interrupted arrangement.

Step width	Theoretical transportation capacity		Effective transportation capacity at a rated speed of		
	$v = 0.5 \text{ m/s}$	$v = 0.5 \text{ m/s}$ uncrowded	$v = 0.5 \text{ m/s}$ convenient	$v = 0.5 \text{ m/s}$ crowded	$v = 0.65 \text{ m/s}$ crowded
600 mm	4500 pers./h	1800 pers./h	2700 pers./h	3600 pers./h	4400 pers./h
800 mm	6750 pers./h	2400 pers./h	3600 pers./h	4800 pers./h	5900 pers./h
1000 mm	9000 pers./h	3000 pers./h	4500 pers./h	6000 pers./h	7300 pers./h

Table according to EN 115-1 (other national regulations can be met)



Single unit

Continuous arrangement (one-way traffic)

**Interrupted Arrangement
(One-Way Traffic)**

While relatively inconvenient for the user, for the owner of the department store it provides the advantage that due to the spatial separation of the upward and downward directions, customers have to walk past specially placed merchandise displays.

**Parallel, Interrupted Arrangement
(Two-Way Traffic)**

This arrangement is used mainly in department stores and public transportation buildings with heavy traffic volumes. When there are three or more escalators or moving walks, it should be possible to reverse the direction of travel depending on the traffic flow.

**Crisscross, Continuous Arrangement
(Two-Way Traffic)**

This type of installation is the one used most frequently as it allows customers to travel quickly to the upper floors without any waiting time. Depending on how the escalators are positioned, the store fitter can open up the view onto the shop floor to stimulate customer interest in the goods on display.



Interrupted arrangement
(one-way traffic)



Parallel, interrupted arrangement
(two-way traffic)



Crisscross, continuous arrangement
(two-way traffic)

Basic Planning

Proper Inclination

Escalators

Inclinations of 30° and 35° are the common international standard for escalators.

30° Inclination

This inclination provides the highest traveling comfort and maximum safety for the user.

35° Inclination

The 35° escalator is the most space-efficient solution. However, this inclination is perceived as too steep if rises exceed 6 m – particularly in downward travel. According to EN 115-1, a 35° inclination is not permissible for rises above 6 m.

Moving Walks

Inclinations of 10°, 11°, and 12° are the common international standard for inclined moving walks.

Users find that a 10° inclination provides the most comfortable ride. A 12° inclination is used when space is limited.

Horizontal moving walks without transition curves can generally be provided for inclinations between 0° and 6°.

Escalators

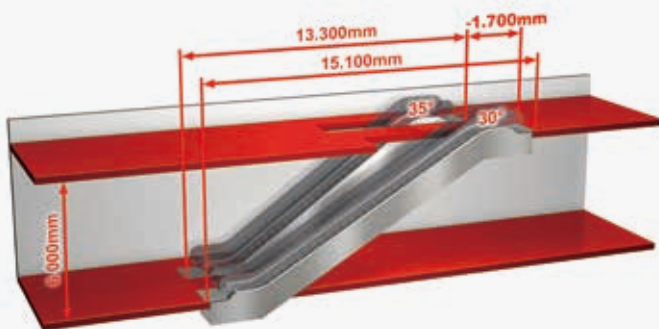

Moving walks

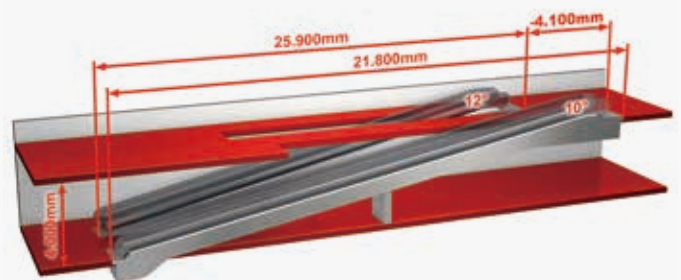

Optimal Step/Pallet Widths

Escalators

Escalators are available with step widths of 600, 800 and 1000 mm. The most popular step width is 1000 mm. This step width gives the user unimpeded access to the step band, even with baggage and shopping bags. The other two step widths are used mainly for less frequented units or where space is restricted.

Moving Walks

Moving walks are suitable for transporting shopping or baggage carts.

Inclined moving walks are available with pallet widths of 1000 mm and 1100 mm.

A moving walk width of 1100 mm is generally recommended as the pallets should always be at least 400 mm wider than the shopping carts when moving walks are operated with shopping carts.

Horizontal moving walks are available with a pallet width of 1000 mm, 1200 mm and 1400 mm. At airports, there is an increasing tendency to use 1200 or 1400 mm wide moving walks, since this width easily allows users to step around passengers with baggage carts.

If a number of escalators or moving walks are to be installed in a continuous arrangement in a building, the same step or pallet width should be selected for all units in order to avoid local congestion.



Basic Planning

Optimal Speed

Speed not only has a considerable impact on the potential transportation capacity of escalators and moving walks, it also influences the space requirements. The tables below summarize the different product configurations depending on speed.

0.5 m/s for Continuous Customer Flow

This is the optimal speed for all escalators and moving walks in the commercial sector. The combination of sufficient transportation capacity, optimal safety, and minimum space requirement makes this speed the worldwide standard for this application.

Escalators: Table according to EN 115-1 (other national regulations can be met)					
Rise	Speed	Maximum inclination	Horizontal step run (mm)	Radii of curvature (m)	
				top	bottom
H ≤ 6 m	≤ 0.5 m/s	35°	800	R ≥ 1	R ≥ 1
	> 0.5 ≤ 0.65 m/s	30°	1200	R ≥ 1,5	R ≥ 1
	> 0.65 ≤ 0.75 m/s	30°	1600	R ≥ 2,6	R ≥ 2
H > 6 m	≤ 0.5 m/s	30°	1200	R ≥ 1	R ≥ 1
	> 0.5 ≤ 0.65 m/s	30°	1200	R ≥ 1,5	R ≥ 1
	> 0.65 ≤ 0.75 m/s	30°	1600	R ≥ 2,6	R ≥ 2

Moving walks: Table according to EN 115-1 (other national regulations can be met) No regulation for radii of curvature			
Rise	Speed	Inclination	Horizontal pallet run (mm)
not limited	≤ 0.75 m/s *	0°-6°	not required
by standards		10°-12°	400 at the top
	> 0.75 ≤ 0.9 m/s *	max. 12°	1600 at top and bottom, pallet width ≤ 1.1 m
	≥ 0.5 m/s **	10°-12°	

* v ≤ 0.65 m/s is recommended

** In the case of moving walk operation with shopping or baggage carts

0.6 or 0.65 m/s for Intermittent Transportation Requirements

This speed is recommended for intermittent passenger arrivals, as at railway stations or subway stations. It has also proven effective at trade fair centers. Longer horizontal runs and larger transition curves are required at these speeds to guarantee optimal safety and loading factor of the escalator/ moving walk.

0.75 m/s for Extreme Transportation Capacity

Although speeds up to 0.75 m/s (escalators) and up to 0.9 m/s (moving walks) are possible, they are not recommended as the effective transportation capacity will not increase any further and there is an increased danger of children or elderly people tripping or falling in the landing areas.

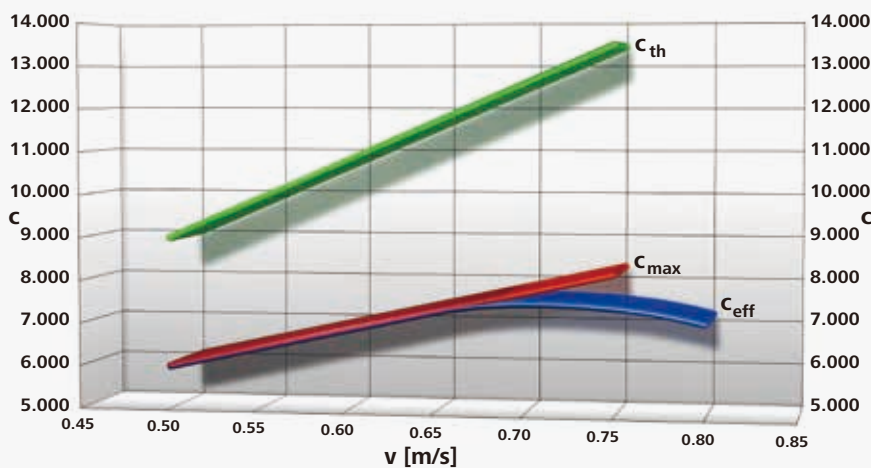

Transportation capacity c (persons/h) as a function of speed

c = theoretical transportation capacity (persons/h) for a nominal width of 1000 mm

- c_{th} = c theoretical
 - c_{max} = c maximal
 - c_{eff} = c effective
- v = speed in m/s

Detailed Planning

Standards

The European EN 115-1 standard defines the safe structural design and safe installation of escalators and moving walks in buildings. The planning instructions in this brochure refer to these regulations.

The standard-compliant inclination and speed have already been discussed under **Proper Inclination and Optimal Speed**.

Transportation of Disabled Persons, Transportation of Baby Carriages

Escalators and moving walks are **not** suitable for transporting wheelchairs and baby carriages. It is recommended to post a sign in the access area of escalators and moving walks indicating where the nearest elevators are located.

Space Requirement

Step/Pallet Run

The correct number of horizontal steps/pallets in the landing areas (i.e., the step/pallet run) of escalators and inclined moving walks according to EN 115-1 depends on the rise, the inclination, and the rated speed. The standard-compliant step/pallet run is indicated in the two tables under **Optimal Speed on page 12**.

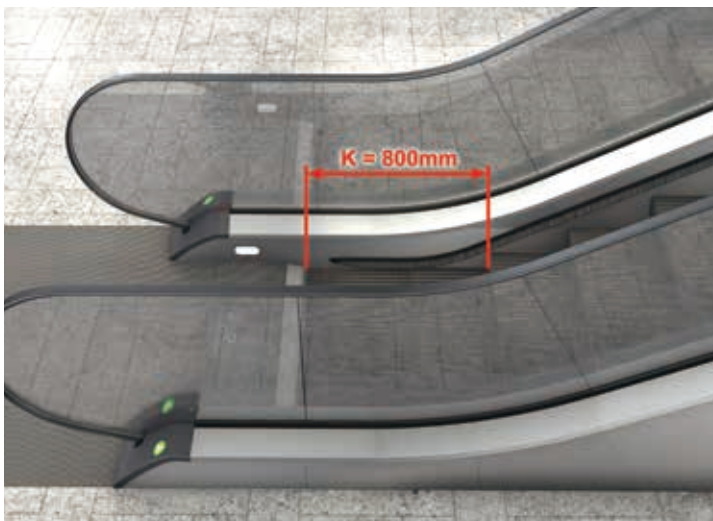

Free Space

To ensure safe use of the escalators and moving walks, a sufficient amount of free space must be provided at the upper and lower landings (see figure below for minimum dimensions according to EN 115-1).

Fixed stairs are forbidden in the unrestricted area. This area must be flat. A maximum inclination of 6° is permissible. For space after the period the value of Ca, please refer to the dimension sheets at the end of this brochure.

For moving walks that are expected to have a high traffic volume and that are also designed for transporting shopping and baggage carts, the free spaces should have a length of at least 5 m. Passenger guide bars, as shown in the picture below, need to be installed outside the free space, otherwise special regulations according to EN 115-4 have to be applied.

Safety, Regulation-Compliant

Balustrade Height

Balustrades are available in heights of 900, 1000 and 1100 mm. The advantage of 900 mm balustrades is that even small children can easily reach the handrail. For greater fall heights we recommend balustrades with a continuous height of 1000 mm. A balustrade height of 1100 mm is also available if required under national regulations.

Overhead Clearance

The free overhead clearance at every point along the step/pallet band must be at least 2.3 m.

Safety Clearances

The horizontal clearance from the outer edge of the handrail to the walls or other obstacles must always be at least 80 mm. This clearance must be maintained up to a height of at least 2.1 m above the step/pallet band. With vertical walls, all Schindler escalators and moving walks provide the specified safety clearance of 80 mm.

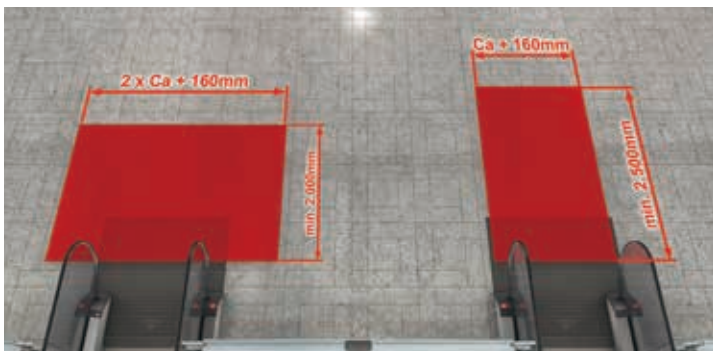

Overhead clearance

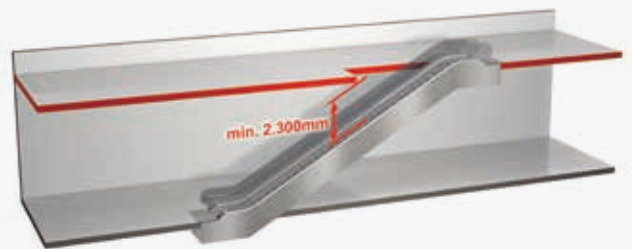

min. 400 mm, otherwise wedging guard required



Detailed Planning

Ceiling Deflectors, Wedging Guards

With escalators and moving walks arranged in a crisscross pattern or with floor openings, there is a risk of wedging between balustrades and adjacent escalator/moving walks or ceilings and columns. If the distance between the outer edge of the handrail and the obstacle is less than 400 mm, wedging guards or ceiling deflectors are to be provided.

Deflectors must be rigidly mounted in order to meet all requirements. A pendulously mounted deflector can be used in addition to the mandatory rigidly mounted deflector.

Protective Barriers

Appropriate structural measures must be installed to prevent people from accessing escalators or moving walks from the side. Protective barriers and guards should be provided on the balustrades where necessary.

Protective barriers, guards against climbing the balustrades, ceiling deflectors, and wedging guards can also be supplied by Schindler as an option.

Protective barrier between balustrades

Wedging guard

Guards against climbing the balustrades



- 1 Wedging guards
- 2 Ceiling deflectors

Railings Provided by the Customer

Railings are to be fitted by the customer at the accesses to the escalators and moving walks. The distance to the handrail of the escalator/moving walk must be at least 80 mm. It is recommended that the support for the escalator/moving walk be at least 1000 mm away from the ceiling edge, so that the balustrade does not have to be extended.

Railing installed by customer

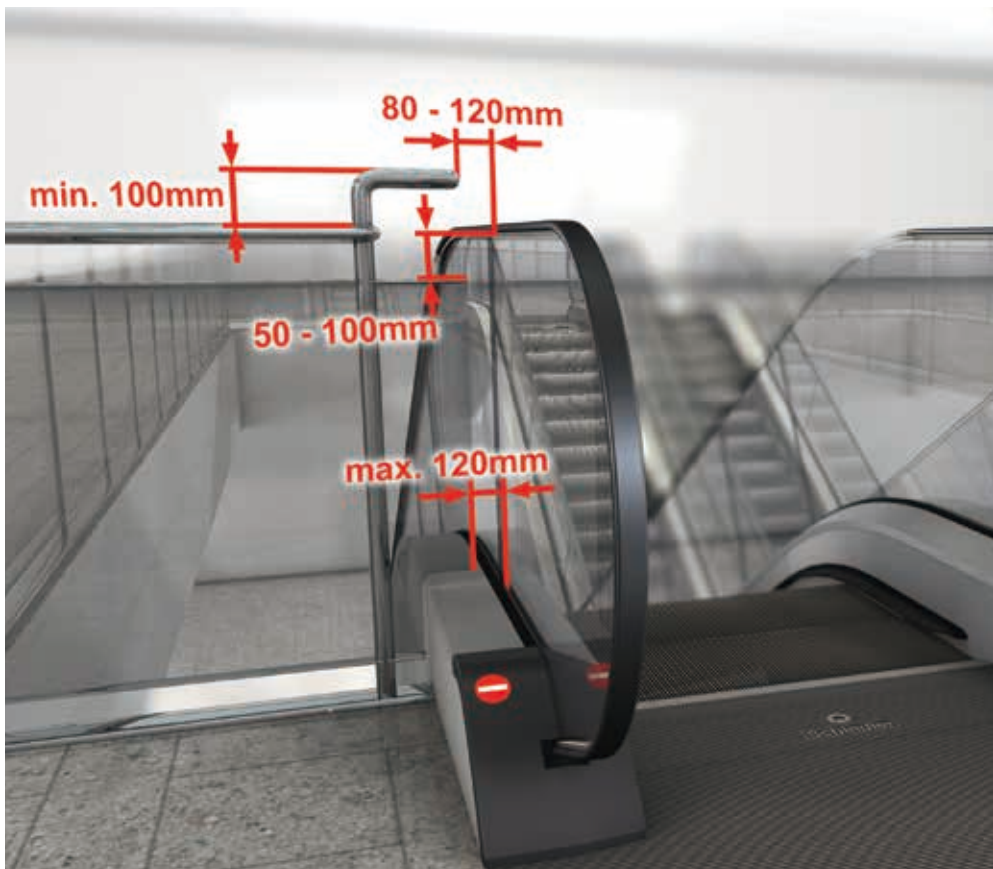

Detailed Planning

Operating Modes and Energy Efficiency

The operating mode of the escalators/moving walks can be adapted to the application. There are essentially three operating modes:

- continuous operation
- stop & go operation
- continuous operation with crawling

Schindler escalators and moving walks offer optimized energy-saving packages for all three operating modes.

ECO

Continuous operation is the optimal mode for the commercial sector in which customers are to be transported efficiently to the upper floors of the store.

ECO Plus

Stop & go operation is recommended for the intermittent arrival of passengers or for sporadic use outside peak times. Typical applications include movie theaters and airports. When there are no

passengers, the unit remains ready for operation as signaled by a direction indicator. The Schindler entrance monitoring system detects approaching passengers and sets the escalator/moving walk into motion whenever required.

ECO Premium

In continuous operation with crawling, the escalator/moving walk continues to crawl at 0.1 m/s in the absence of passengers, using a frequency converter. Mechanical wear is considerably lower than in conventional stop & go operation, and in this operating mode the readiness for operation and the direction of travel are indicated by the slowly moving steps.

ECO Premium Plus

As the top of the range, the ECO Premium Plus package offers the highest energy-saving potential. It combines the energy-saving functions of the ECO Plus and the ECO Premium packages and features stop & go operation together with stand-by speed operation. For top energy efficiency, high-efficiency drives and motors must be specified.

Four packages to save energy

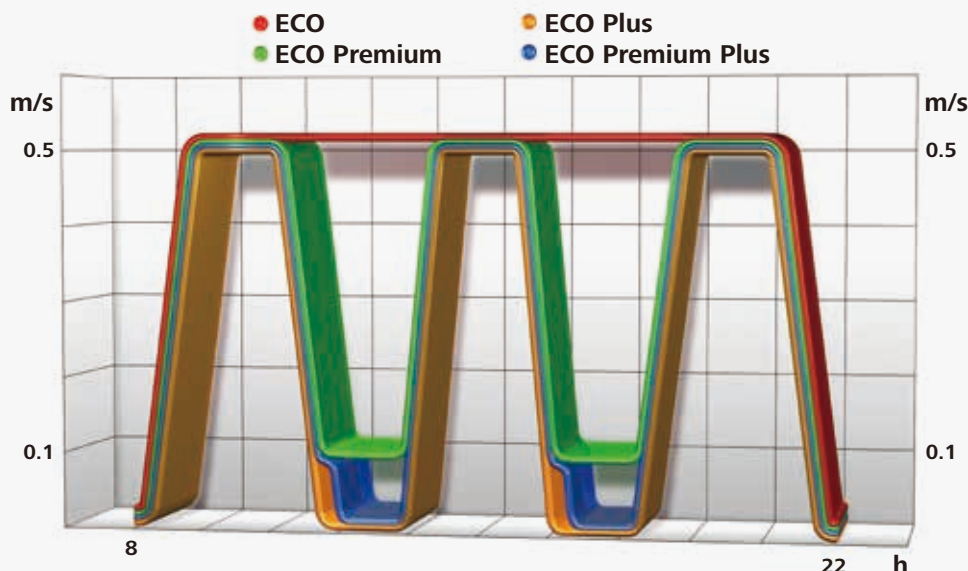

Special Applications

Outdoor Installation

Special measures are required for escalators and moving walks that are installed outdoors and are therefore subject to the effects of weather conditions. These measures are necessary to achieve optimal unit availability and the longest possible service life for the components. For more detailed information, please contact our experts.

Extreme Locations

For applications that require sturdiness and safety under extreme transportation conditions, we recommend our balustrade design I. This inclined balustrade, which is made of 12 mm thick, shock-resistant stainless-steel sandwich panels, provides optimal operation in ski resorts, outdoor applications or in regions susceptible to vandalism.

Moving Walk Operation With Shopping Carts

Only suitably designed shopping carts (in accordance with EN 1929-2 and EN 1929-4) and baggage carts may be used on moving walks. Access to the moving walk entrance must be blocked for non-specified carts.

The width of each shopping or baggage cart and its contents must be at least 400 mm less than the nominal pallet width, since passengers must be able to walk past any cart on the moving walk. For moving walks with an inclination greater than 6°, the rated speed must be limited to 0.5 m/s. Shopping or baggage carts must conform to the moving walk design:

- The design must ensure safe and correct loading.
- The maximum weight must not exceed 160 kg when loaded.
- A braking or blocking system must be fitted to enable automatic locking on the inclined section of moving walks.
- The carts must be equipped with deflectors (bumpers) to reduce the risk of getting stuck.
- To ensure safe exit from the moving walk, the blocking system of the rear rollers of shopping or baggage carts must lock onto the pallet in order to push the front rollers over the combs. The front rollers and/or blocking system must release easily from the pallet.
- Deflectors and guiding devices must be provided in the surrounding area to ensure correct alignment when entering the moving walk.
- Safety signs about safe and correct use of shopping or baggage carts must be posted.



Detailed Planning

Escalator Operation

With Shopping or Baggage Carts

For safety reasons, the transportation of shopping and baggage carts on escalators is not allowed. If they must be transported, moving walks must be installed.

If it is reasonably foreseeable that trolleys will be taken onto an escalator, then suitable barriers acc. EN 115-4 must be installed to prevent this occurrence.

Additional stops for emergency situations at the exit, with a distance between 2.0 m and 3.0 m before the comb intersection line, must be provided.



The Best Product for Your Premises

Schindler escalators and moving walks are ideally designed for use in all the relevant application segments. The modular structure of Schindler escalators and moving walks means that the components required can be adapted to each application while retaining the same outer design.

The following table provides an overview of the product types and their main application segments.

	Escalators		Moving walks	
	Schindler 9300AE	Schindler 9700	Schindler 9500AE	
	Type 10	Type 20/30	Inclined moving walk	Horizontal moving walk
Shopping center	X		X	
Store	X			
DIY store, supermarket	X		X	
Hotel, office building	X			
Movie theater	X			
Museum	X			
Library	X		X	
Trade fair center		X	X	X
Airport	X	X		X
Railway/subway station		X	X	X



The Best Product for Your Premises

Schindler 9300AE

With its individual configuration packages, the Schindler 9300AE offers a process-optimized solution to your requirements.

The Schindler 9300AE-10 escalator comprises the variants and option packages most often specified for escalators in department stores and the retail sector.

The Schindler 9300AE-20 escalator also fulfills the special requirements and specifications of the public transportation sector. The technical equipment featured by this range of products complies with all the requirements in this segment, combined with an outstanding aesthetic design.

Schindler 9700

This sturdy product line is ideal for large rises and the special extreme duty requirements of public transportation. Our experts will be happy to advise you.

Schindler 9500AE

Schindler offers the world's most complete range of products in the global moving walk market. Inclined moving walks with widths of up to 1100 mm are designed to be used with shopping carts. With widths of up to 1400 mm, horizontal moving walks perfectly cover the public transportation requirements at airports, trade fair centers or other facilities.

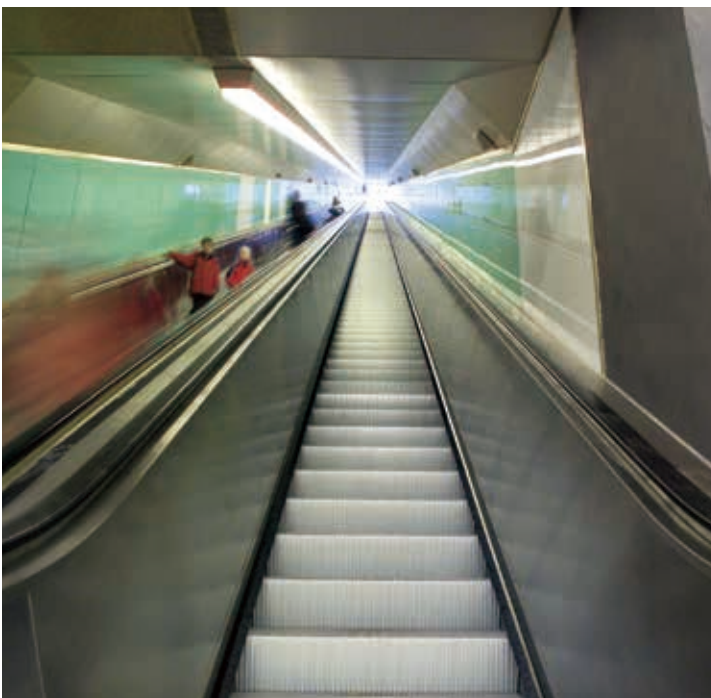

Services Provided by the Customer, Site Preparations

Optimal planning and preparation of on-site transportation and the moving of the escalator/moving walk into the building are essential for ensuring the best possible installation sequence and thereby minimizing building costs. Escalators/moving walks are entirely preassembled at the factory. This is why planning on-site transportation of the escalators/moving walks, which can be up to 17 m long and weigh up to 100 kN, is such a key step in the planning process.

Planning is based on the technical specifications in our dimension sheets or on the layout drawing specific to the project.

As a matter of principle, we recommend that you coordinate the date and time as well as how the escalator/moving walk will be moved into the building and the access route with our experts PLENTY OF TIME IN ADVANCE.

The key points involved in this process are summarized below.

Moving the Escalator or Moving Walk Into the Building

A suitable area for unloading the escalator/moving walk from the truck has to be provided in front of the building. The access routes to the building and the installation site must be level and accessible with roller dollies.

Essentially, there are two possibilities for moving the escalator/moving walk into the building:

- Through ground-floor openings in the building using special forklift trucks
- Through appropriate side openings in the building or roof using an on-site or mobile crane



Services Provided by the Customer, Site Preparations

Transportation to the Installation Site

The clearance over the entire access route must not be less than the minimum dimension stipulated in the dimension sheet/layout drawing. (Don't forget suspended pipes or lines.)

The type of delivery has to be stipulated at the time of the release for production. After that date the escalators/moving walks can no longer be designed in several parts.

The required entrance width depends on the width of the escalator/moving walk. Given the length of the escalator/moving walk, make sure all curves and bends can be negotiated easily. We recommend that you plot out the entire transportation route on a CAD plan or paper model.

The entire transportation route must be level and free of obstacles, and be able to withstand particular floor loads. If not, the appropriate load distribution has to be provided. Our experts can advise you.



Delivery Modes

The escalator/moving walk is usually ordered fully assembled, in one part.

If there is insufficient clearance, the escalator/moving walk can be supplied with the balustrades not mounted.

In the case of long escalators/moving walks or restricted space conditions, the escalator/moving walk can be delivered in two or more parts. However, due to the increased transportation and assembly costs this form of delivery should be used only where unavoidable.

Recess Clearances, Floor Openings, Supports

Please refer to our dimension sheets and the project-specific layout drawing for all the necessary recess clearances, floor openings and supports.

Suspension Points to Be Provided by the Customer

Suspension points for pulley blocks for the proper movement and placement of the escalator/moving walk are to be provided by the customer. The suspension points must be positioned along the symmetry axis of the escalator/moving walk above the end supports and – where applicable – the intermediate supports. The exact position is indicated on our layout drawings. The suspension points must be rated for a load of 50 kN.

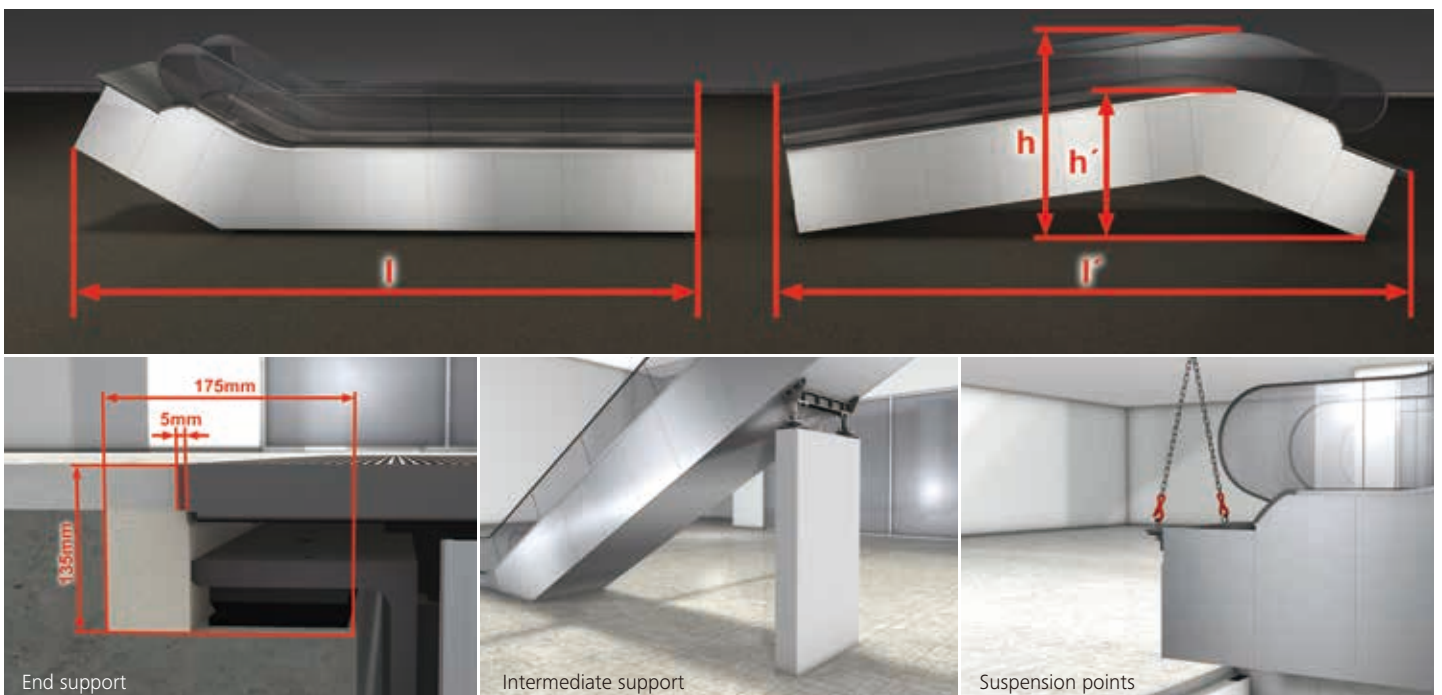

Services Provided by the Customer, Site Preparations

Connections to Other Installations

Electrical Connections

The electrical connection is generally made at the upper escalator/moving walk station as shown in the figure. The number and minimum cross-section of the connecting cables are specified in our layout drawing. The supply connection is to be provided by the customer through an authorized electrician.

Sprinklers

If required by the customer, sprinkler tubing can optionally be fitted to the escalator/moving walk. The installation of the sprinkler heads and the connection of the sprinkler tubing are to be provided by the customer through an authorized specialist.

Fire Control System

The applicable national regulations for commissioning fire control systems must be observed.

Oil Separator

An oil separator has to be fitted when installing escalators/moving walks outdoors. If the oil separator is supplied by Schindler (optional), the customer must provide a recess in the escalator/moving walk pit and a water drain.



From Production Release to Final Installation

Once the detailed planning is completed, you will receive from us a project planning sheet or a layout drawing based on your indications and containing all the relevant information such as escalator/moving walk geometry, support loads, and key electrical data. You can also draw up this plan yourself using SchindlerDraw at www.schindler.com.

Production Release

Next, you give the go-ahead for the production of the escalator/moving walk by signing the valid project planning sheet or the layout drawing and returning it to us. Check once again that the main dimensions of the escalator/moving walk correspond with the dimensions of your building structure. Our installation team will be happy to coordinate the access route as well as the moving and placement logistics with you once again.

Site Preparation Inspection

Before your escalator/moving walk is delivered, our installation team examines on site the supports and the installation dimensions. Acceptance of the preparations to be made by the customer, i.e., electrical connections, transportation routes, etc., is also carried out with the site management.

Transportation From Factory to Site

Depending on the delivery mode, the escalators/moving walks are delivered by truck (or in a container for deliveries overseas). Given the possible excess lengths and heights, official approvals may be necessary for the transportation to the site.



From Production Release to Final Installation

Moving the Escalator/Moving Walk Into the Building

Moving the escalator/moving walk into the building up to the supports is a critical process that requires meticulous preparations (see **Services Provided by the Customer, Site Preparations**).

Once the escalator/moving walk has been unloaded by crane or forklift truck, the escalator/moving walk is placed on roller dollies and towed by forklift truck. To minimize the on-site transportation logistics, it is extremely important to keep the transportation route as short and as straight as possible.

Setting Down Onto the End Supports

Usually, suspension points in the form of ceiling plates or ceiling openings with a diameter of 50 mm are prepared by the customer in accordance with the indications on the layout drawing to secure the hoisting gear. These points are used to hoist the escalators/moving walks and set them down onto the supports. Each suspension point must have a load-bearing capacity of at least 50 kN.

If no suspension points are provided by the customer, installation scaffolds are used. This installation method takes longer and involves more materials.

If the roof or ceiling opening is sufficiently large, a crane can be used to set the escalator/moving walk down onto its end supports from above.

Because a certain amount of time will probably elapse between the placing of the escalator/moving walk and its commissioning, the unit should be adequately protected against dirt and damage due to building work.



The covering fitted by Schindler should be removed only during commissioning. The escalator is not to be used as a fixed stairway during the construction phase (increased risk of dirt, soiling, and damage).

Any dirt that cannot be removed can affect the service life of mechanical and electrical components.

Final Installation, Commissioning

Upon completion of installation, the escalator/ moving walk is thoroughly checked once more during a test run. At the handover, you will be given the customer documentation and the keys for the unit.

In some countries, acceptance by an authorized verification body is necessary prior to commissioning. Commissioning can then proceed as usual.

Please note that the unit has to be kept in a safe operating state by an authorized maintenance organization. We at Schindler are at your disposal around the clock for such services.

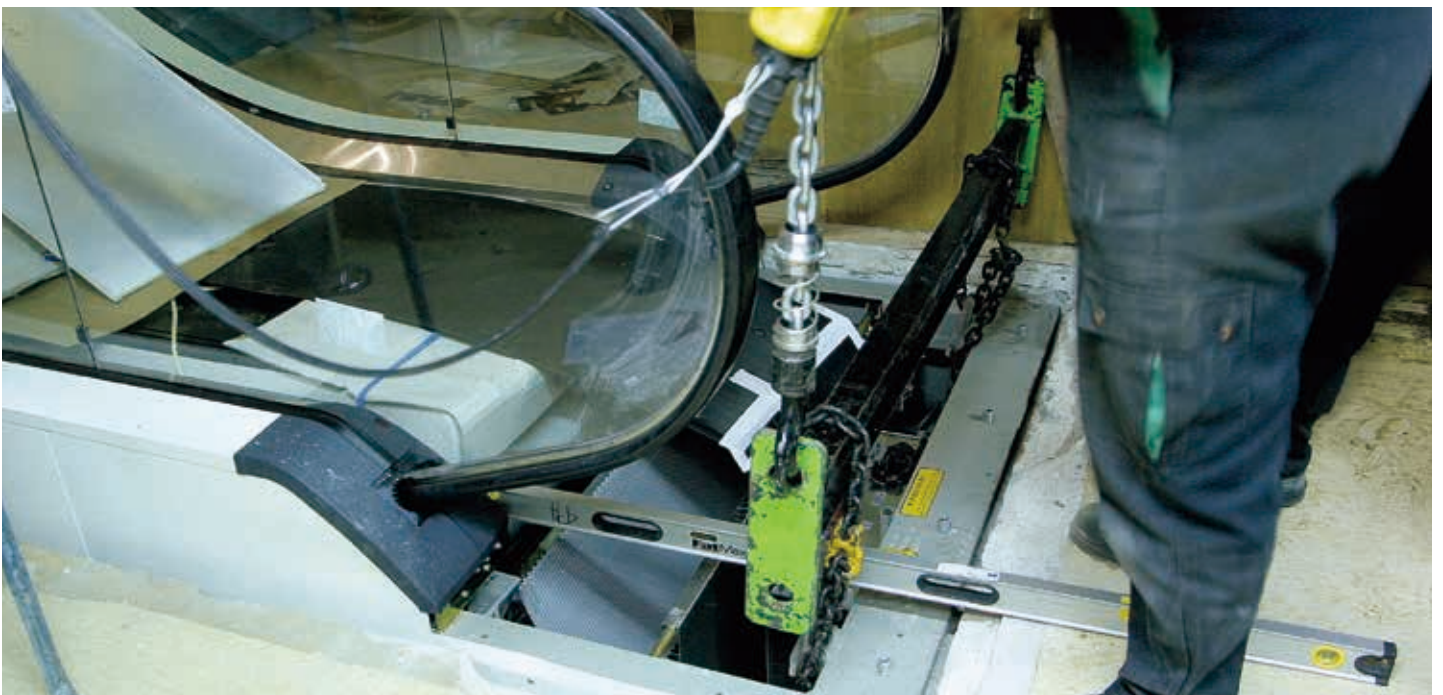

Interactive Configuration With SchindlerDraw

For project-specific configurations we recommend SchindlerDraw, the interactive online configuration tool available at www.schindler.com.

With SchindlerDraw, you can create and download project-specific *.dxf and *.dwg files as well as neutral specification texts to suit the data you have. The projects remain stored in your personal project center, where they can also be processed at a later stage.

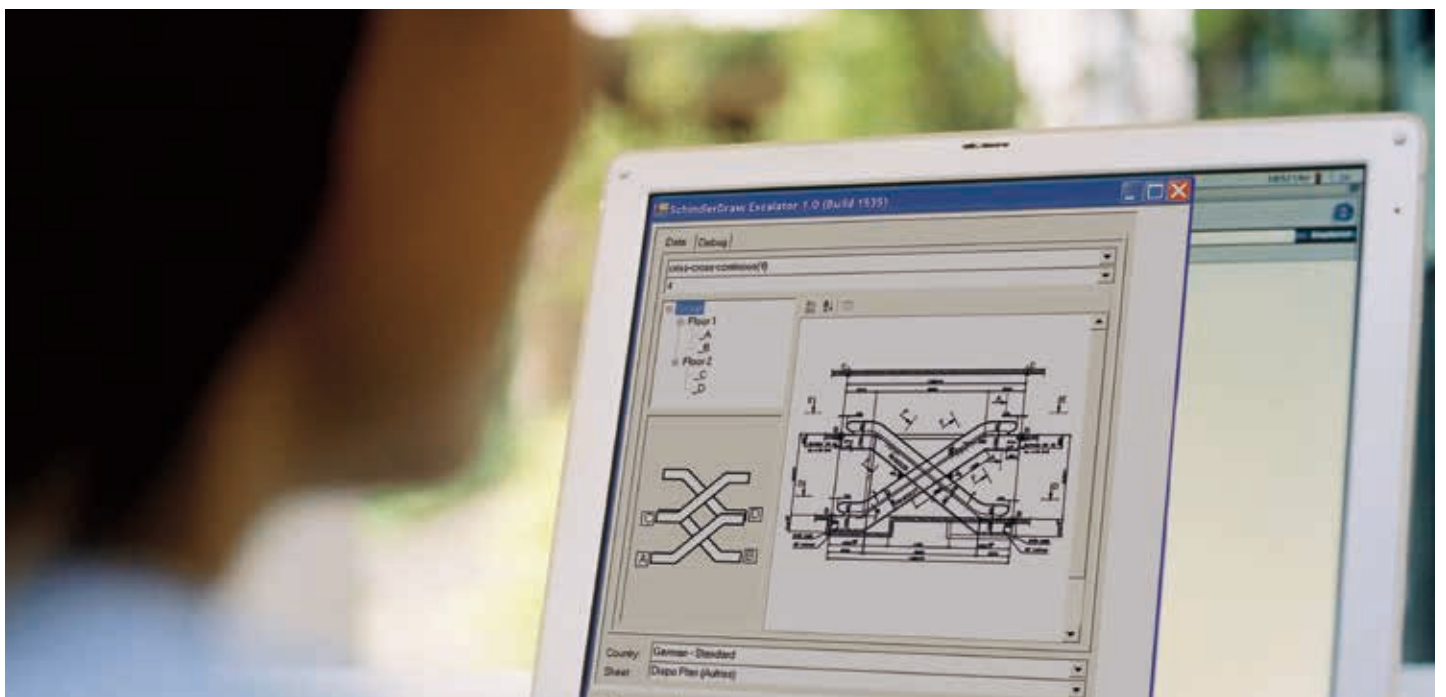

Key Points for the Planning Process

Checklist

Approval of the Layout Drawing

- c Pit dimensions
- c Rise
- c Support distance and dimensions
- c Electrical feed lines
- c Sprinkler connections, if necessary
- c Phone connection for remote monitoring
- c Water drain for outdoor installation

Services to Be Provided by the Customer

- c Masonry, scaffolding, and cutting work
- c Structural supports for the escalator or moving walk supports
- c Protective railings for the upper floor opening, if necessary
- c Power supply to the escalator or moving walk main switch
- c Phone line for remote monitoring
- c Erection of scaffolding and barriers, provision of openings, removal of doors and portals (if necessary to bring the unit inside the building)
- c Covering of finished floor with planking and, if necessary, support of floors for transportation and suspension of the unit in the building
- c Any incurred acceptance and testing fees
- c Satisfactory covering of the unit to protect against damage and dirt until commissioning
- c Erection of barriers to protect against unauthorized access to the unit (e.g., site barriers, warning signs)
- c Protective barriers, ceiling deflectors, wedging guards (optionally supplied by Schindler)
- c Cleaning of the unit to remove dirt accumulated during construction, if necessary
- c Water drain, oil separators as per building codes

And remember, if you have any questions, our experts are always available to help you.

Disclaimer

The specifications, options, and colors mentioned in this brochure are indicative only and are subject to change without notice. They are not intended to, and do not, constitute an offer on the part of the Schindler Group.

Schindler 9300AE

Type 10 · 30°-K

Rise: max. 6 m at a step width of 1000 mm
Balustrade: design E
Balustrade height: 900/1000 mm

Inclination: 30°
Step width: 600/800/1000 mm
Step run: 2 horizontal steps

All dimensions in mm.
 Observe national regulations!
 Subject to change.

The stated loads are characteristic values according to EN 1990.

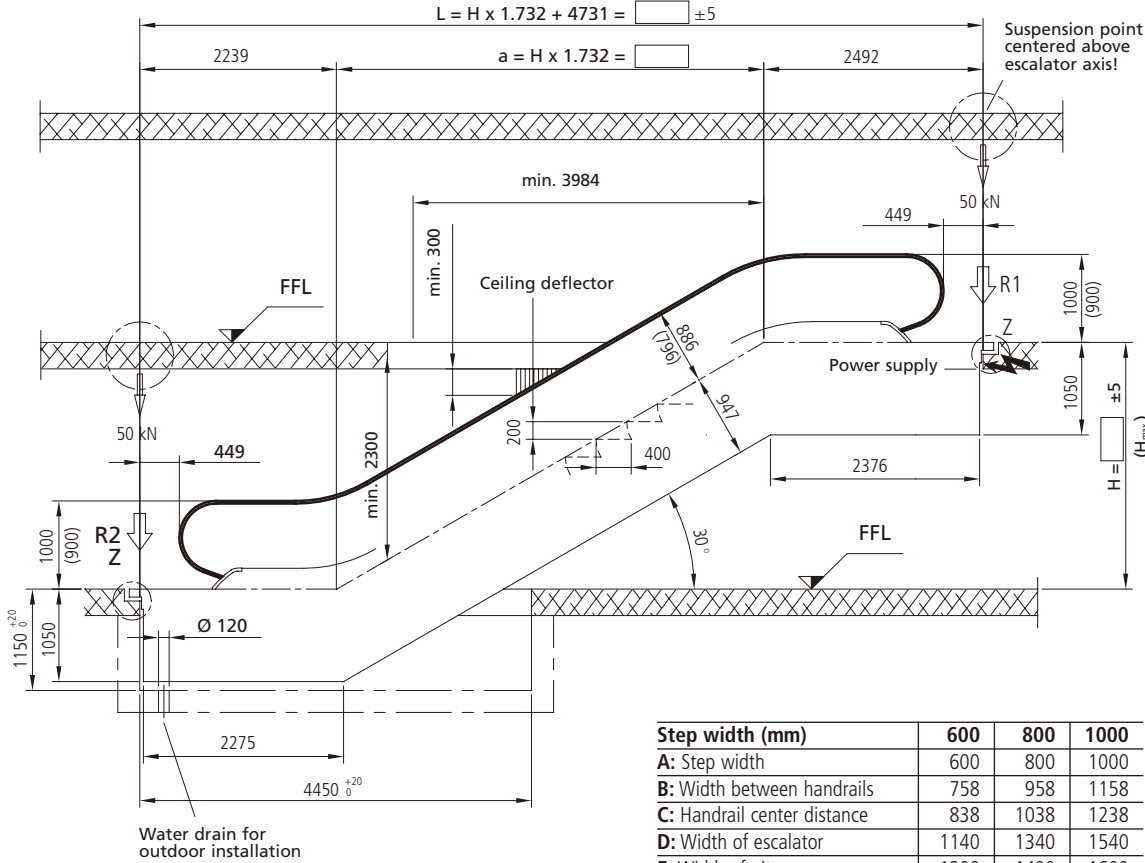

Step width (mm)	600	800	1000
A: Step width	600	800	1000
B: Width between handrails	758	958	1158
C: Handrail center distance	838	1038	1238
D: Width of escalator	1140	1340	1540
E: Width of pit	1200	1400	1600
H _{max} : Maximum rise	6000	6000	6000
C _A : Distance between outer faces of handrails	918	1118	1318

Transportation dimensions

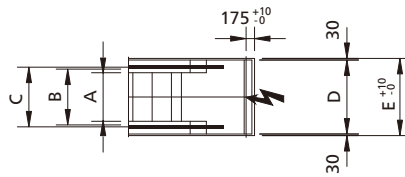
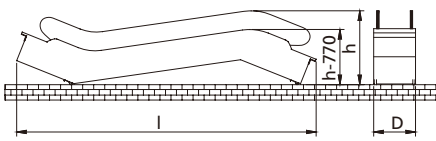

Detail Z

Gaps at joints to be filled with joint filler (by customer)

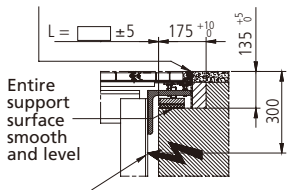

Inlet for lighting and power circuits centered at upper end, through front face

Step width A mm	Rise H mm	Weight kN	Support loads		Transp. dimensions Balustrade height 1000	
			R1 kN	R2 kN	h	l
600	3000	52	44	38	2740	10860
	3500	56	47	41	2760	11850
	4000	59	50	44	2780	12840
	4500	62	53	47	2800	13840
	5000	65	56	50	2820	14830
	5500	69	58	53	2830	15830
800	6000	72	61	56	2840	16820
	3000	55	50	45	2740	10860
	3500	59	54	48	2760	11850
	4000	62	57	52	2780	12840
	4500	66	61	55	2800	13840
	5000	69	64	58	2820	14830
1000	5500	73	68	62	2830	15830
	6000	76	71	65	2840	16820
	3000	59	57	51	2740	10860
	3500	62	61	55	2760	11850
	4000	66	65	59	2780	12840
	4500	70	69	63	2800	13840
	5000	73	73	67	2820	14830
	5500	85	82	74	2830	15830
	6000	89	86	79	2840	16820

Schindler 9300AE

Type 10 · 30°-M

Rise: max. 8 m at a step width of 1000 mm
Balustrade: design E
Balustrade height: 900/1000 mm

Inclination: 30°
Step width: 600/800/1000 mm
Step run: 3 horizontal steps

- 1) If $L > L_{max.}$, an intermediate support may be required; please consult Schindler.
- 2) Delivery in 2 parts.

All dimensions in mm. Observe national regulations! Subject to change.

The stated loads are characteristic values according to EN 1990.

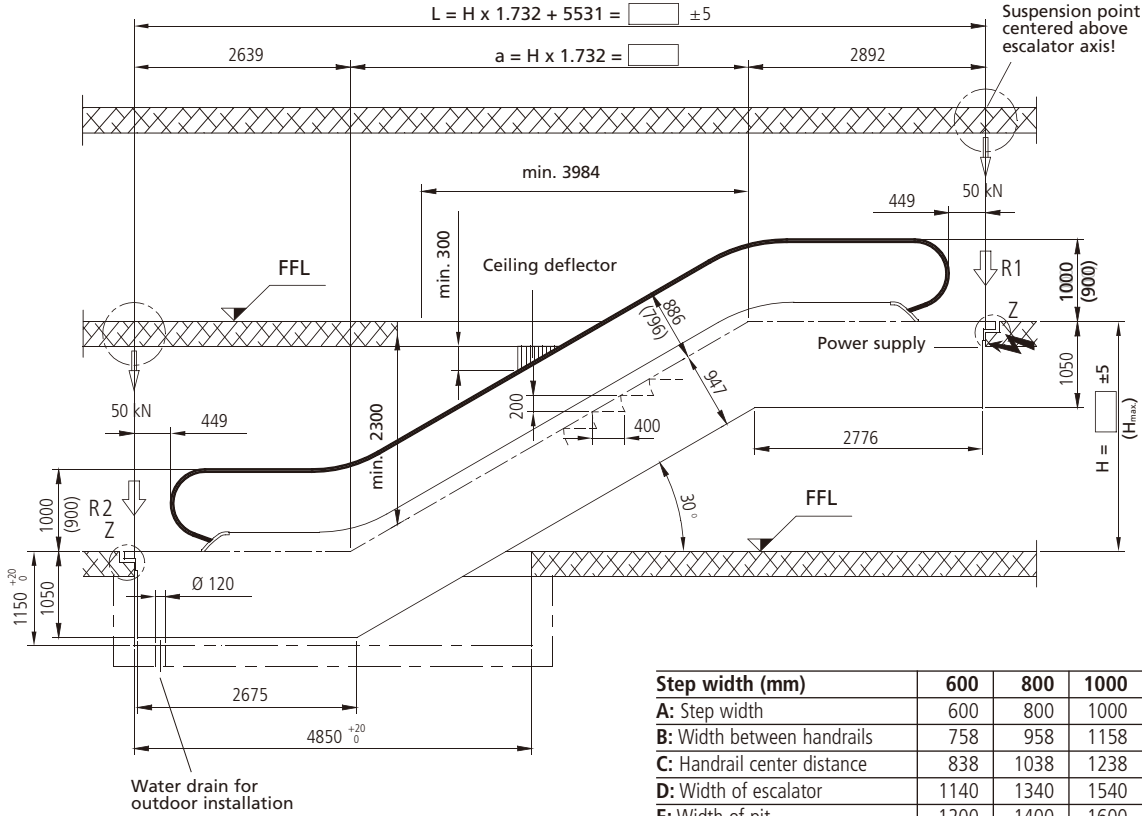

Step width (mm)	600	800	1000
A: Step width	600	800	1000
B: Width between handrails	758	958	1158
C: Handrail center distance	838	1038	1238
D: Width of escalator	1140	1340	1540
E: Width of pit	1200	1400	1600
$L_{max.}^{1)}$: Limiting span length	19300	17600	16200
$H_{max.}$: Maximum rise	12000	9300	8000
Ca.: Distance between outer faces of handrails	918	1118	1318

Transportation dimensions

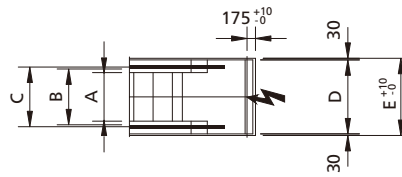
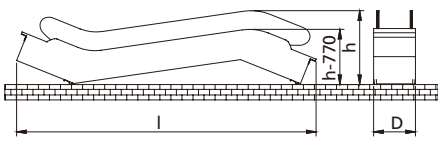

Detail Z

Gaps at joints to be filled with joint filler (by customer)

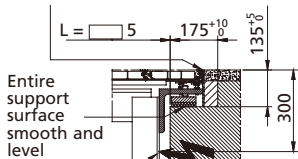

Entire support surface smooth and level
 Inlet for lighting and power circuits centered at upper end, through front face

Step width A mm	Rise H mm	Weight kN	Support loads		Transp. dimensions Balustrade height 1000	
			R1 kN	R2 kN	h	l
600	3000	58	48	42	2850	11610
	3500	61	51	45	2880	12590
	4000	65	54	48	2910	13580
	4500	68	57	51	2930	14570
	5000	72	60	54	2950	15570
	5500	75	63	57	2970	16560
800	6000	78	66	60	²⁾	²⁾
	3000	61	55	49	2850	11610
	3500	65	58	53	2880	12590
	4000	68	62	56	2910	13580
	4500	72	65	60	2930	14570
	5000	76	69	63	2950	15570
1000	5500	82	74	68	2970	16560
	6000	86	78	72	²⁾	²⁾
	3000	65	62	56	2850	11610
	3500	69	66	61	2880	12590
	4000	73	70	65	2910	13580
	4500	79	76	70	2930	14570
	5000	83	80	74	2950	15570
	5500	90	87	79	2970	16560
	6000	94	91	83	²⁾	²⁾

Schindler 9300AE

Type 10 · 35°-K

Rise: max. 6 m at a step width of 1000 mm
Balustrade: design E
Balustrade height: 900/1000 mm

Inclination: 35°
Step width: 600/800/1000 mm
Step run: 2 horizontal steps

All dimensions in mm.
 Observe national regulations!
 Subject to change.

The stated loads are characteristic values according to EN 1990.

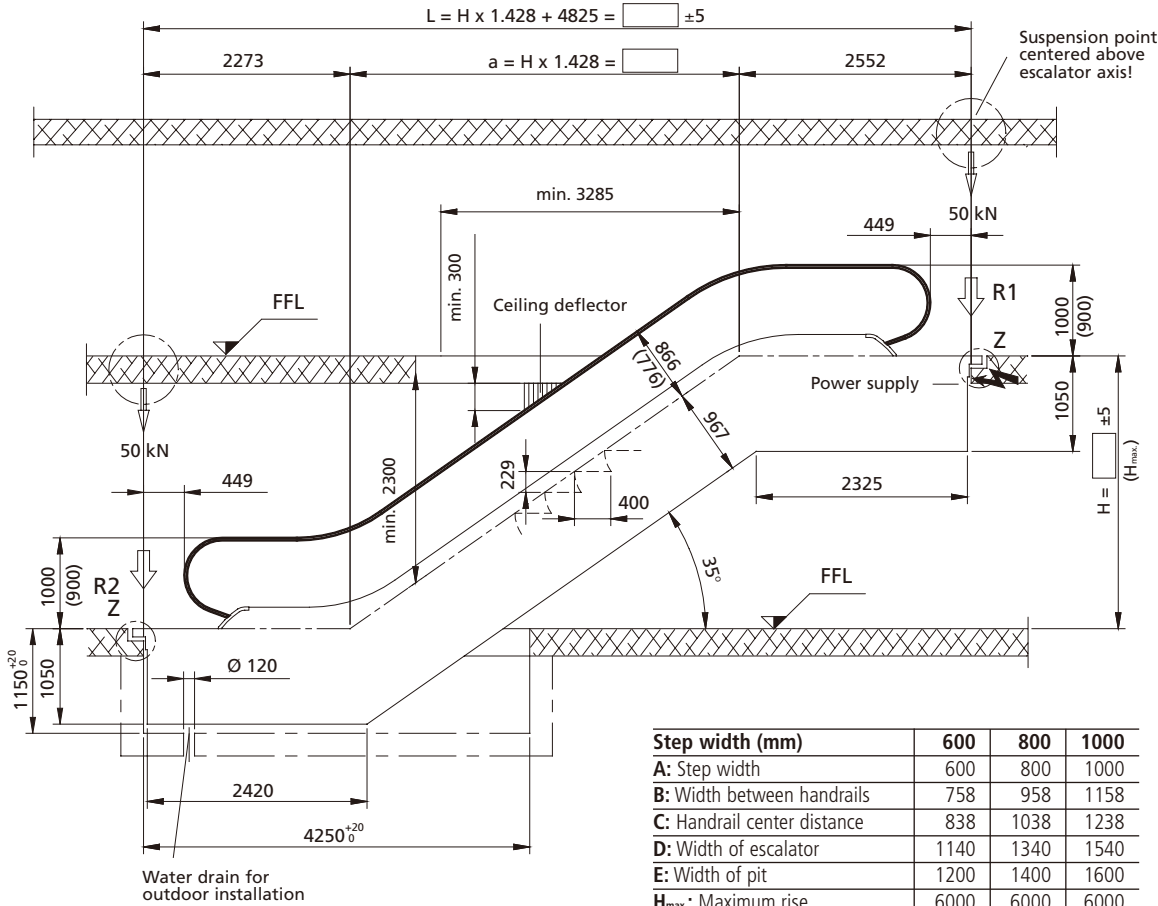

Step width (mm)	600	800	1000
A: Step width	600	800	1000
B: Width between handrails	758	958	1158
C: Handrail center distance	838	1038	1238
D: Width of escalator	1140	1340	1540
E: Width of pit	1200	1400	1600
H _{max} : Maximum rise	6000	6000	6000
C.A.: Distance between outer faces of handrails	918	1118	1318

Transportation dimensions

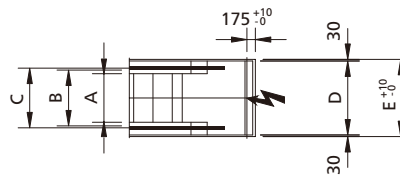
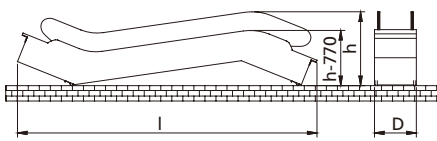

Detail Z

Gaps at joints to be filled with joint filler (by customer)

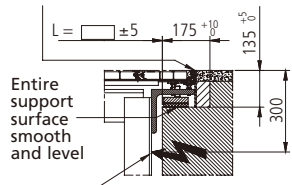

Inlet for lighting and power circuits centered at upper end, through front face

Step width A mm	Rise H mm	Weight kN	Support loads		Transp. dimensions	
			R1 kN	R2 kN	Balustrade height h	l
600	3000	49	41	35	2820	10110
	3500	52	44	38	2850	10960
	4000	55	46	40	2880	11820
	4500	58	49	43	2900	12680
	5000	60	51	45	2910	13540
	5500	63	53	48	2930	14400
800	3000	52	47	41	2820	10110
	3500	55	50	44	2850	10960
	4000	58	53	47	2880	11820
	4500	61	56	50	2900	12680
	5000	64	59	53	2910	13540
	5500	67	62	56	2930	14400
1000	3000	55	53	47	2820	10110
	3500	58	57	51	2850	10960
	4000	62	60	54	2880	11820
	4500	65	63	58	2900	12680
	5000	68	67	61	2910	13540
	5500	71	70	64	2930	14400
	6000	83	79	71	2940	15270

Schindler 9300AE

Type 20 · 30°-M

Rise: max. 13 m at a step width of 1000 mm
Balustrade: design E
Balustrade height: 900/1000 mm

Inclination: 30°
Step width: 600/800/1000 mm
Step run: 3 horizontal steps

All dimensions in mm.
 Observe national regulations!
 Subject to change.

The stated loads are characteristic values according to EN 1990.

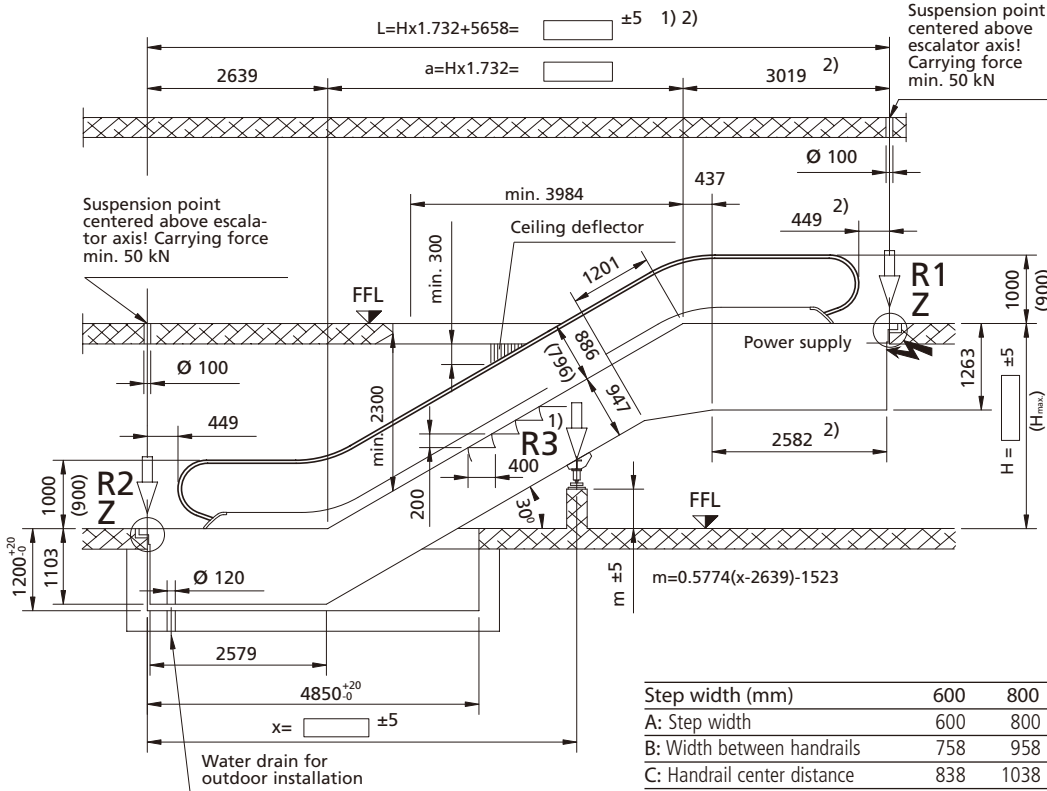

- 1) If $L > L_{max.}$, an intermediate support may be required. Please consult Schindler.
- 2) With a double drive, the truss must be extended by 417 mm.
- 3) With a balustrade height of 900 mm, h is reduced by 70 mm.
- 4) Delivery in min. 2 parts.
- 5) Delivery in at least 3 parts.

Step width (mm)	600	800	1000
A: Step width	600	800	1000
B: Width between handrails	758	958	1158
C: Handrail center distance	838	1038	1238
D: Width of escalator	1140	1340	1540
E: Width of pit	1200	1400	1600
$L_{max.}^{1)}$: Limiting span length	19000	17300	15900
$H_{max.}$: Maximum rise	13000	13000	13000
C_{Δ} : Distance between outer faces of handrails	918	1118	1318

Transportation dimensions

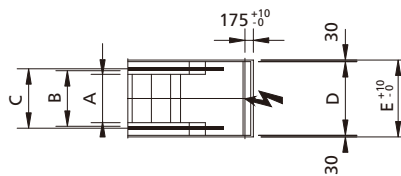
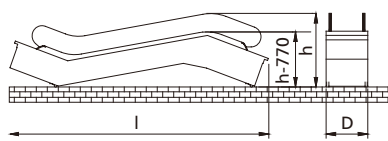

Detail Z

Gaps at joints to be filled with joint filler (by customer)

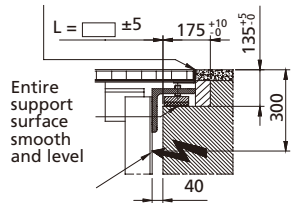

Inlet for lighting and power circuits centered at upper end, through front face

Step width A mm	Rise H mm	Weight kN	Support loads			Transp. dimensions Balustrade height 1000	
			R1 kN	R2 kN	R3 kN	Balustrade height $h^{3)}$	l
800	9000	111	53	44	104	4)	4)
	10000	119	56	47	114	4)	4)
	11000	126	59	49	123	4)	4)
	12000	133	61	52	133	4)	4)
	13000	147	67	58	142	4)	4)
1000	15000	169	78	63	162	5)	5)
	9000	118	60	50	121	4)	4)
	10000	126	63	53	132	4)	4)
	11000	140	69	60	142	4)	4)
	12000	154	78	63	154	4)	4)
	13000	163	81	66	165	4)	4)

Schindler 9500AE

Type 10

Rise: max. 7.5 m at a pallet width of 1000 mm
Balustrade: design E
Balustrade height: 900/1000 mm

Inclination: 10°/11°/12°
Pallet width: 800/1000/1100 mm
Horizontal pallet run: 400 mm

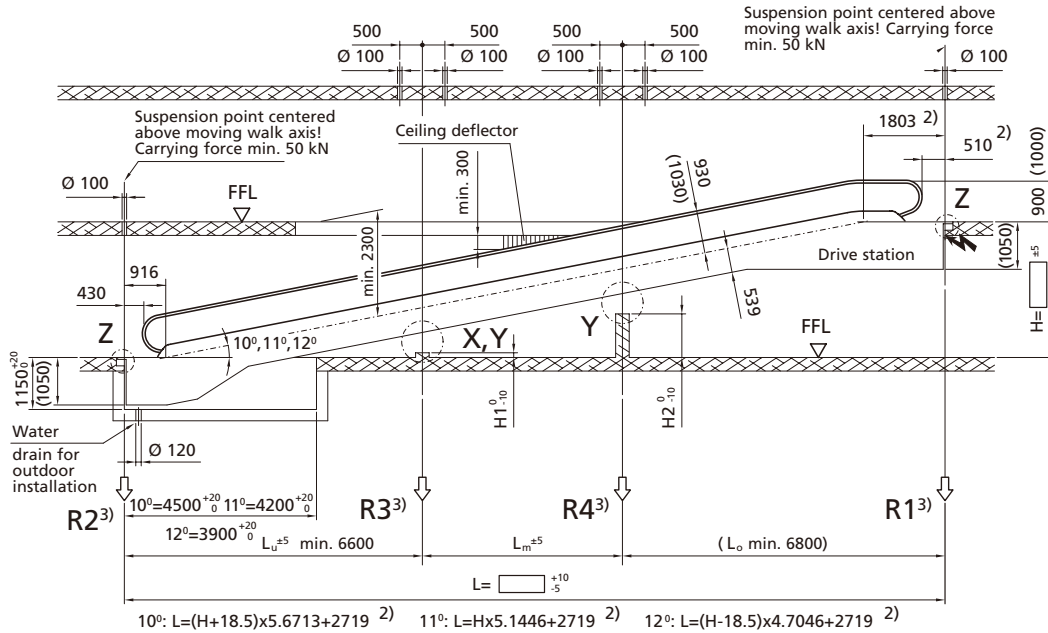

- 1) Calculated on the basis of a deflection of $L / 750$. If $L > L_{max}$, an intermediate support may be required; please consult Schindler. Intermediate support (R3) at a distance of $L / 2$.
- 2) With a double drive, the truss must be extended by 417 mm.
- 3) Support loads for two intermediate supports on request.
- 4) Dimensions for balustrade height of 1,000 mm.
- 5) Free spaces, overhead clearance, safety clearance; ceiling deflectors, wedging guards, and protective barriers according to national regulations (optional supply by Schindler).

All dimensions in mm. Observe national regulations! Subject to change. INT = intermediate support(s)

The stated loads are characteristic values according to EN 1990.

Inclination	Rise	Length	Transp. dimensions in one part		Pallet width A = 800			Pallet width A = 1000			Pallet width A = 1100											
			h ¹⁾	l	Weight (kN)	Supp. loads (kN)			Weight (kN)	Supp. loads (kN)			Weight (kN)	Supp. loads (kN)								
10°	3000	19838	2460	20420	86	39	47	40	34	92	42	50	44	39	108	95	44	52	46	42	116	
	4000	25509	2470	26180	104	48	56	46	41	119	111	51	60	53	139	115	53	62	57	50	149	
	5000	31180	2470	31940	130	61	69	56	50	148	143	67	76	70	168	150	70	80	77	67	178	
12°	3000	16746	2460	17380	77	34	43	36	30	78	82	37	45	40	35	91	85	39	46	42	38	98
	4000	21450	2470	22190	93	42	51	42	36	100	99	45	54	47	41	117	102	47	56	50	44	126
	5000	26155	2470	27000	106	49	57	47	41	122	116	54	62	56	48	143	121	57	65	61	52	154

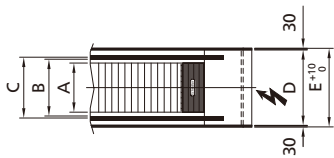

Detail Z

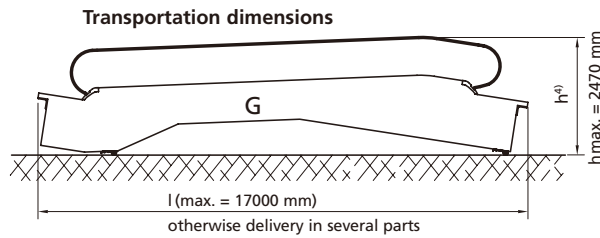
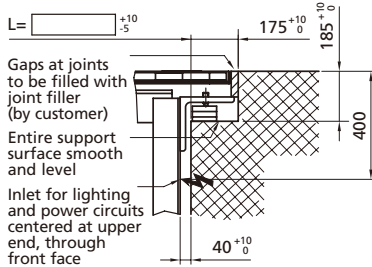

Detail X one intermediate supports

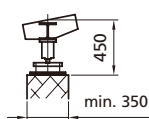

Detail Y two or more intermediate supports

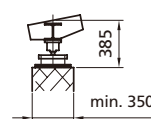

Pallet width	800	1000	1100	1 INT	10°: H1 = Lu x 0.1763 - 1161
					12°: H1 = Lu x 0.2126 - 1192
A: Pallet width	800	1000	1100	2 INT	10°: H1 = Lu x 0.1763 - 1096
B: Width between handrails	958	1158	1258		11°: H1 = Lu x 0.1944 - 1112
C: Handrail center distance	1038	1238	1338		12°: H1 = Lu x 0.2126 - 1127
D: Moving walk width	1340	1540	1640		10°: H2 = H1 + Lm x 0.1763
E: Width of pit	1400	1600	1700		11°: H2 = H1 + Lm x 0.1944
L _{max} ¹⁾ : Limiting span length	16300	15000	14300		12°: H2 = H1 + Lm x 0.2126
H _{max} : Maximum rise	9300	7500	7500		

Schindler 9500

Type 30

Transportation length: max. 100 m
at an inclination of 0°
Balustrade: design E
Balustrade height: 1000 mm

Truss in drive and tension stations
Inclination: 0°-6°
Pallet width: 1000/1200/1400 mm

1) For outdoor installations a water drain shall be provided over the entire length of the concrete pit by customer.

2) The support loads T1 and D1 are equally distributed over the width of the moving walk, whereas the support loads T2, D2, M1, M3 etc. are equally distributed among the supports on the left and right side.

For outdoor installations, feasibility must be checked by the supplying factory on the basis of climatic conditions.

For parallel installation the drive stations must be mounted always on the same end.

All dimensions in mm.

All loads in kN.

Observe national regulations!

Subject to change.

Please consult Schindler.

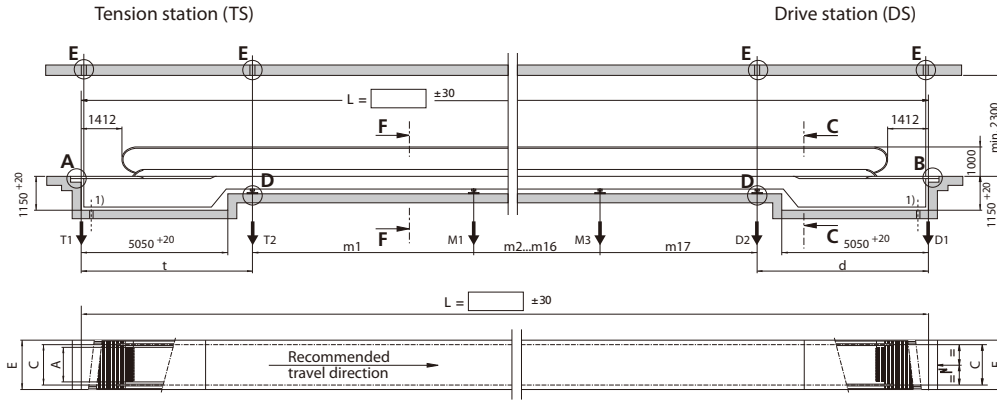

Section F-F

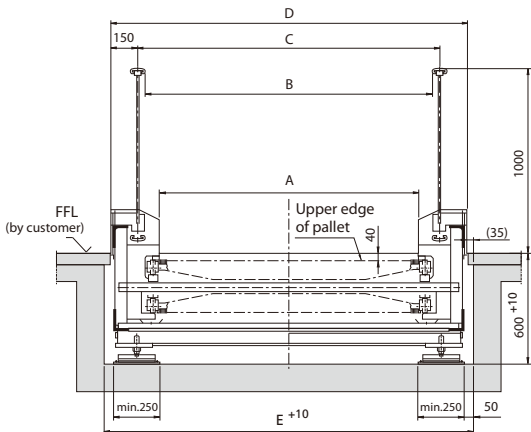

Detail A

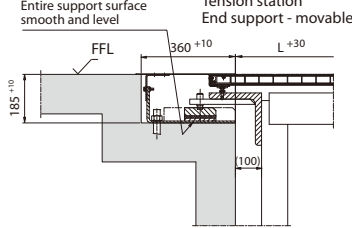

Detail B

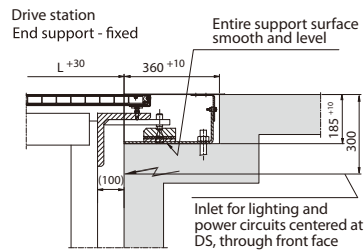

Detail E

Suspension points centered above moving walk axis!
Carrying force min. 50 kN

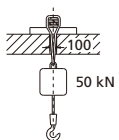

Section C-C

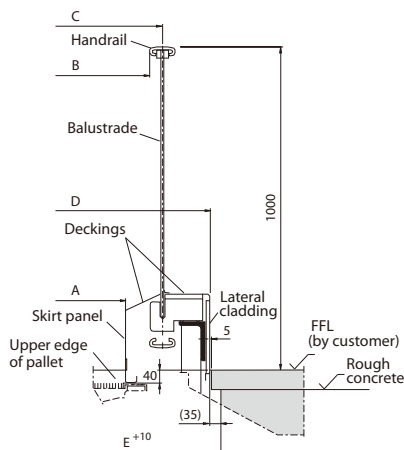

Detail D

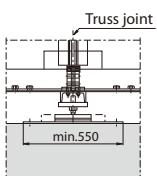

A: Pallet width	1000	1200	1400
B: Width between handrails	1157	1357	1558
C: Handrail center distance	1237	1437	1638
D: Moving walk width	1533	1733	1933
E: Width of pit	1600	1800	2000

Max. support loads (kN) 2)
valid only for maximal support distance

Pallet width (mm)	1000	1200	1400
T1	36	39	42
T2	123	133	142
D1	46	49	52
D2	123	133	142
M1...M17	101	109	118

Support distance
valid for horizontal installation

Width A (mm)	1000	1200	1400
t	min	5900	5900
	max	11500	11000
d	min	5900	5900
	max	11500	11000
m1...m17	min	5751	5501
	max	11500	11000

Schindler 9700 AE

Type 2S · 30°-K, M, L

Balustrade: design I/P
Balustrade height: 1000 mm
Truss: standard

Inclination: 30°
Step width: 800 / 1000 mm
Step run: 2, 3, 4 horizontal steps

The specified dimensions are minimum dimensions; according to the configuration, larger dimensions might apply.

Speed
 $v = 0.5-0.65 \text{ m/s}$
 Nominal rise according to EN 115 with
 $A = 1000 \text{ mm}$
 Size S: max. 13 m

All dimensions in mm. Observe national regulations!
 Subject to changes.

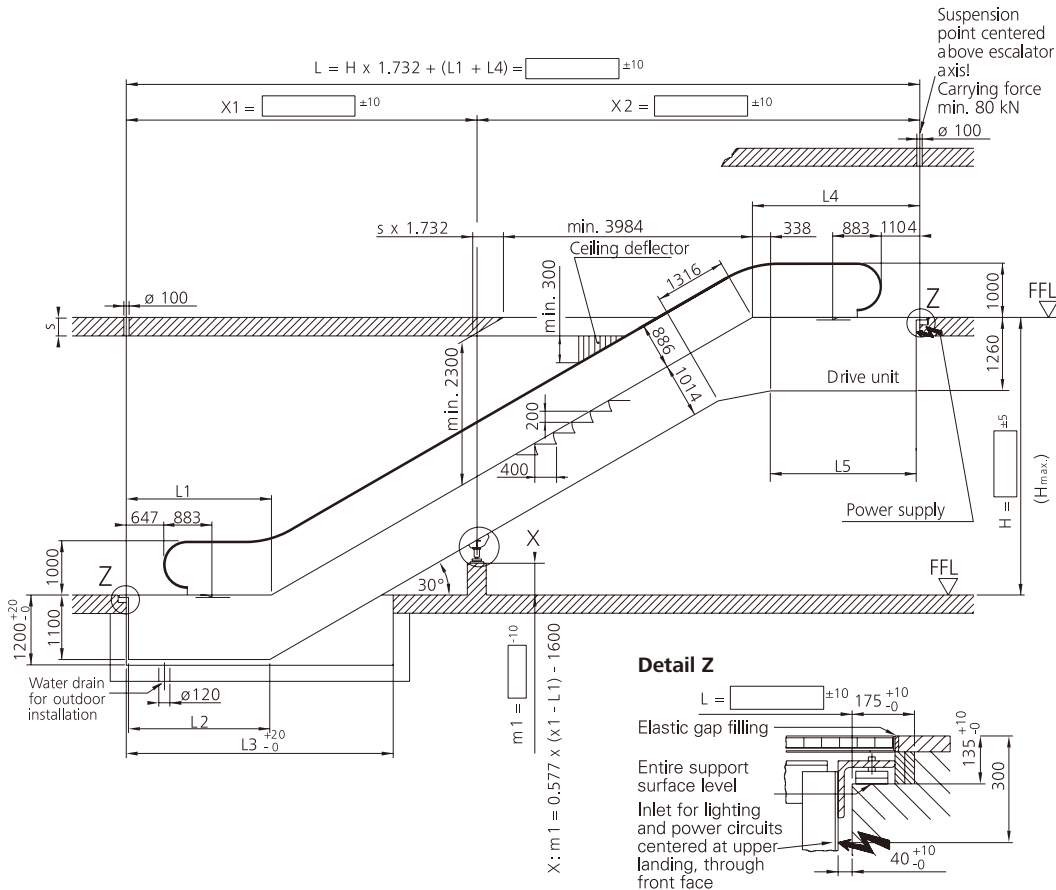

Detail X
 (1 intermediate support)

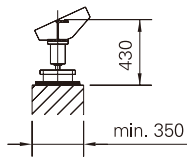

Detail Z

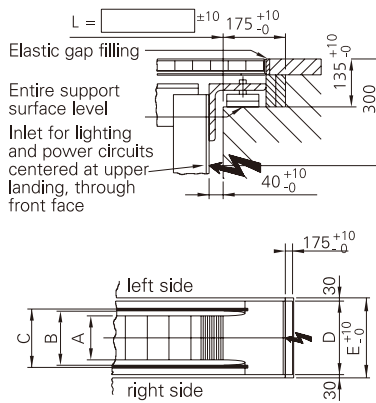

Step run	Step width			Size: S	
	K	M	L	800	1000
L1	2239	2639	3039		
L2	2362	2762	3162		
L3	4570	4970	5370		
L4	3076	3476	3876		
L5	2738	3138	3538		
Lmax.: without intermediate supports				18100	16800
X1,2,3 max.: with intermediate supports				15000	14000

Please contact Schindler for support loads, motor ratings, transportation dimensions, and weights. Please contact Schindler for dimensions relating to truss extensions, double drives, frequency converters, and lighting installations. Please request detailed drawings Z, X and Y for expansion joints, seismic specifications and wind loads respectively from Schindler. Please contact the supplying factory for availability and delivery dates.

Schindler 9700AE

Type 3S · 30°-M, L Truss height 1104

Balustrade: design I / P
Balustrade height: 1000 mm
Truss: standard

Inclination: 30°
Step width: 800 / 1000 mm
Step run: 3, 4 horizontal steps

The specified dimensions are minimum dimensions according to the configuration, larger dimensions might apply.

Speed
 $v = 0.5 - 0.65 \text{ m/s}$
 Nominal rise according to EN 115 with $A = 1000 \text{ mm}$
 max. 16 m

All dimensions in mm.
 Observe national regulations.
 Subject to changes.

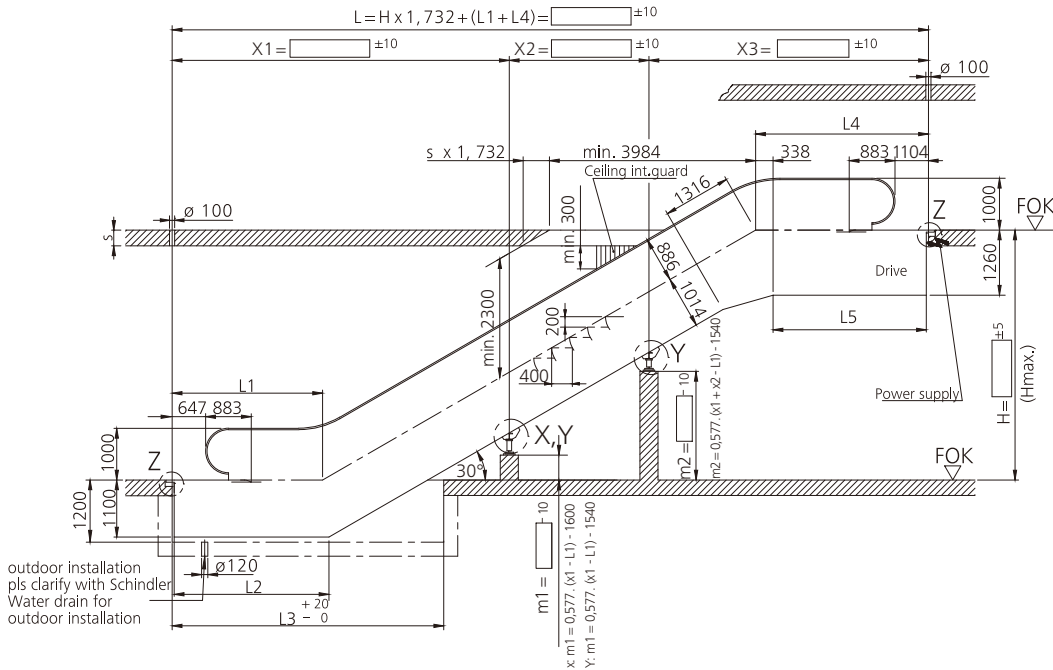

Detail Z

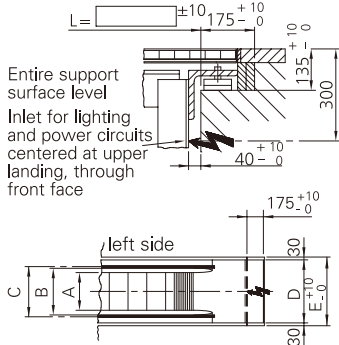

Detail X

(1 intermediate support)

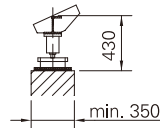

Detail Y

(from 2 intermediate supports upward)

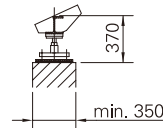

Step run	Step width		Build size: S	
	M	L	800	1000
L1	2907	3307	1060	1260
L2	2990	3390	1140	1340
L3	5250	5650	1440	1640
L4	3797	4197	1500	1700
L5	3419	3819	Lmax.: without intermediate supports	18100 16800
			X1,2,3 : with intermediate supports	15000 14000

Please contact Schindler for support loads, motor rating, transport dimensions and weight !

Please contact Schindler for dimensions relating to truss extensions, double drives, frequency converters and lighting installations.

Please request detail information Z, X and Y for expansion joints, seismic specifications and wind loads respectively from Schindler.

Please contact the supplying factory for availability and delivery date.

For outdoor installation, Please contact Schindler. For speed $V=0.75\text{m/s}$ please contact Schindler.

Schindler

Reliable, Moving, Trailblazing

For generations, Schindler has been providing the finest elevator and escalator technology to architects and builders around the world. Founded in Switzerland in 1874, Schindler is one of the world's leading elevator and escalator manufacturers, with subsidiaries in over one hundred countries. Every day, Schindler solutions help around one billion people get from A to B.

For further information, including the location of the Schindler office nearest you, please visit:

www.schindler.com