

## Schindler 6200 – New Generation

Small space? Think big.  
The adaptable replacement elevator  
for smaller shafts.

**According to EN 81 20/50**  
New European standards



# Space constraints? Here's the creative solution

## ➤ Evolved to adapt

Small spaces call for creativity and versatility. The new generation Schindler 6200 elevator offers an intelligent, highly competitive solution for very small or narrow shafts.

## ➤ Maximum flexibility in minimal spaces

The Schindler 6200 adapts to the constraints of small shafts to ensure the maximum possible space inside the elevator, given by finely adjustable car dimensions and door position, layout and drive variability.

## ➤ Green mobility

Every aspect of the Schindler 6200 is geared towards maximum efficiency. So whatever your requirements, you know it's a sound solution, both economically and ecologically.

## ➤ Attractive design for small spaces

With 4 design lines, 33 matching colours and a wide choice of décor options, the Schindler 6200 will complement the style of your building and comply with the European standard.

### Key Specifications

Capacity	180 to 630 kg, 1 to 8 passengers
Travel height	max. 45 m, max. 19 stops
Entrances	one-sided
Car width	600* to 1,100 mm (in 5 mm increments)
Car depth	710 to 1,400 mm (in 5 mm increments)
Car door	telescopic doors (T2), center-telescopic doors (C4), folding door (4 panels)
Landing doors	automatic or semi-automatic (reuse of swing doors)
Door frames	usage of existing frames or new frames or complete new metal shaft front
Door width	600 to 900* mm (in 50 mm increments)
Door height	2,000 or 2,100 mm
Drive	gearless technology
Speed	1.00 m/s
Control	push-button control: pick-up collective, down collective and selective collective
Interior	two style sets and four décor lines or Libertà concept

\* Door type depending

# Evolved to adapt

Small spaces call for creativity and versatility. The new generation Schindler 6200 elevator offers an intelligent, highly competitive solution for very small or narrow shafts. Combining comfort and safety with flexibility and energy efficiency, it will effortlessly meet the requirements of your building and the people who use it.

## Fits the spaces other elevators can't

In residential or smaller commercial buildings with limited shaft space, the replacement of an elevator is not an easy task. The new generation Schindler 6200 offers a creative solution. Designed to be installed in small or narrow elevator shafts or stair holes, the new generation Schindler 6200 serves the places other elevators can't reach.

### Intelligent use of space

The new generation Schindler 6200 makes the best possible use of the available space to fit each shaft perfectly, down to the last millimeter. The combination of finely adjustable car dimensions, flexible door and counterweight positioning and optimization of all shaft components leads to full use of the shaft volume. This means a larger load capacity and maximum comfort for passengers.

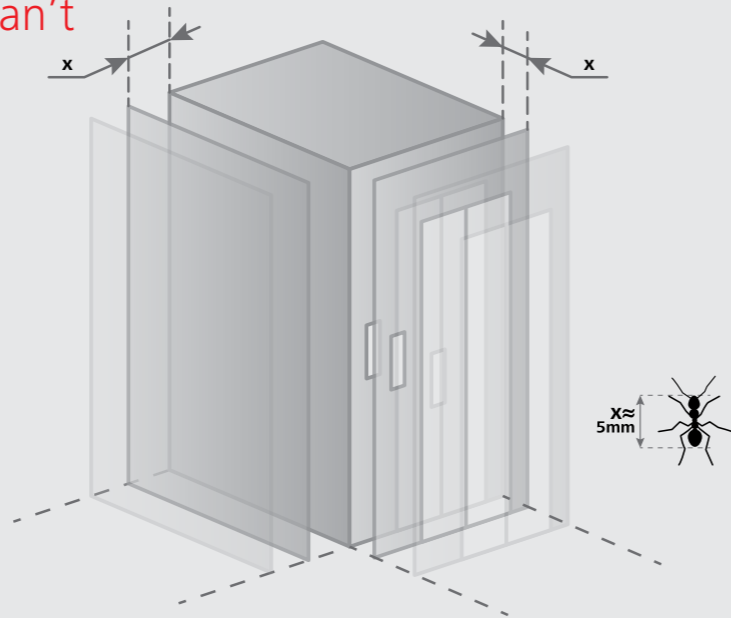

Thanks to its advanced technology, the Schindler 6200's dimensions can be fine-tuned in increments in the size of ant.

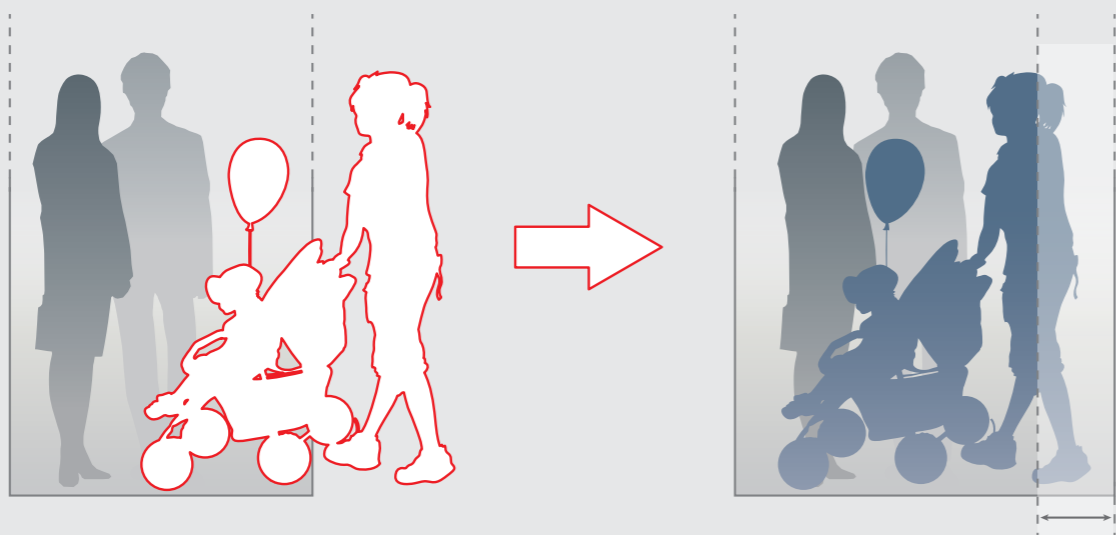

Before Schindler 6200 creative solutions

After Schindler 6200 creative solutions

## Non-standard situations, standard process

Do you need the precision and personalization of a made-to-measure elevator? Or are you looking for the reliability and cost-effectiveness of a standardized product? With the new generation Schindler 6200, you can have the best of both worlds.

Using standard components and processes, it can be configured in endless different permutations, creating a unique solution for each building.

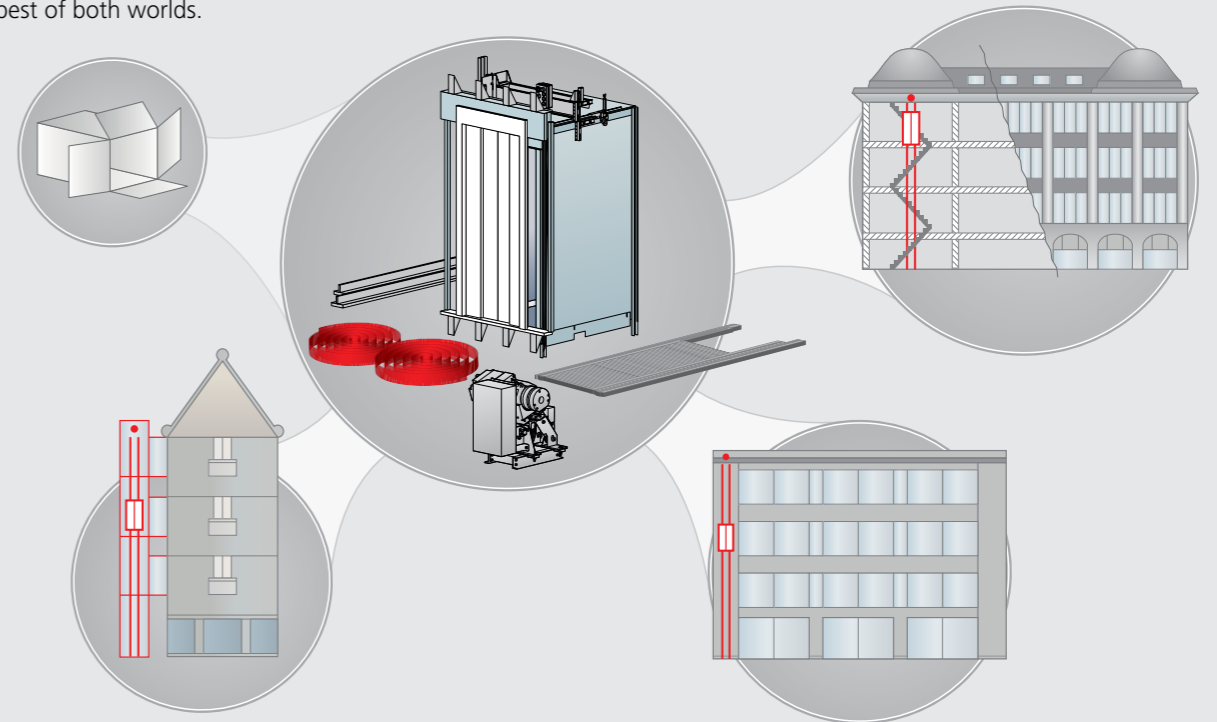

## A fully-packed new generation

### Less downtime, less disruption

When you decide to replace the elevator in your building, you want to keep building works and disturbances to a minimum. So you'll be glad to know we've set new standards for reducing the building adaptations required and speeding up the installation process. In fact, installing the new generation Schindler 6200 can take 40% to 50% less time than the installation of a conventional elevator replacement. So residents can look forward to minimum downtime and minimum disruption of their daily routine.

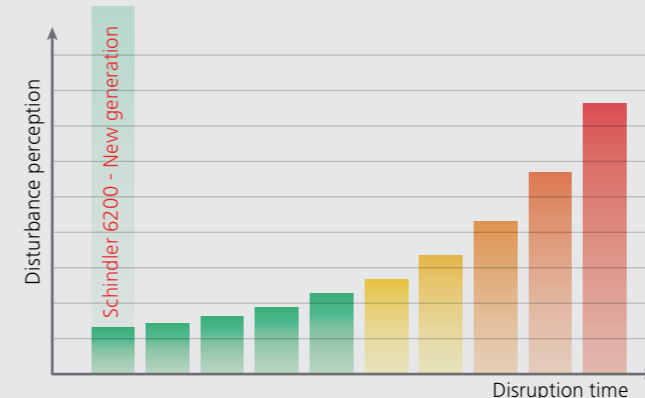

### Ride in silent comfort

The combination of modern design, sophisticated gearless technology and top quality components means the new generation Schindler 6200 offers unbeatable ride comfort. It's also remarkably quiet, thanks to a series of measures to keep noise emission to an absolute minimum.

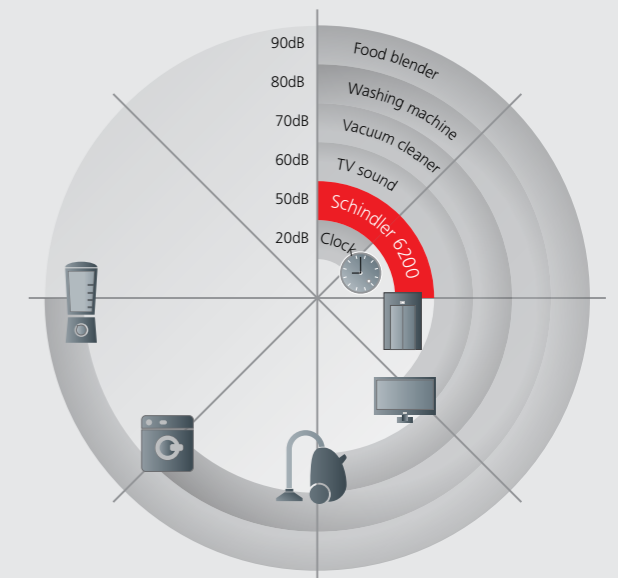

# Maximum flexibility in minimal spaces

The new generation Schindler 6200 is designed to optimize the use of the available space in very small shafts, thanks to a series of adaptable elements. From the machine and the counterweight to the door, car and shaft materials, maximum space efficiency is built in to every component.

## A perfect fit

The new generation Schindler 6200 adapts to the constraints of small shafts to ensure the maximum possible space inside the elevator. The dimensions of the car can be adjusted in increments of just 5 mm to fit the available space precisely, optimizing shaft components and minimizing gaps to moving parts. And thanks to a highly flexible system, the door position can be fine-tuned in increments of a single millimeter, thereby avoiding building works.

### A question of balance: the counterweight

The counterweight's dimensions, guiding system and distance from the wall are all optimized for small shafts. It can be installed in either a rear or lateral rear position, depending on the requirements of the building. A rear counterweight maximizes car width by minimizing the distance between the car and the side walls, while the rear lateral counterweight is ideal for narrow but deeper shafts.

Lateral rear counterweight

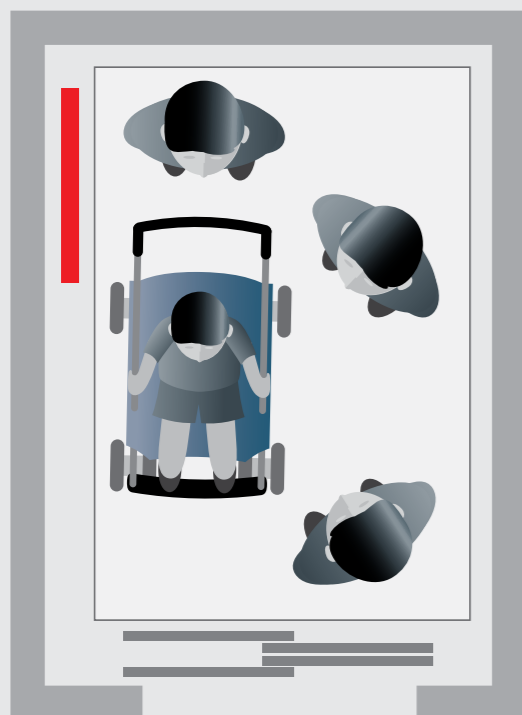

Rear counterweight

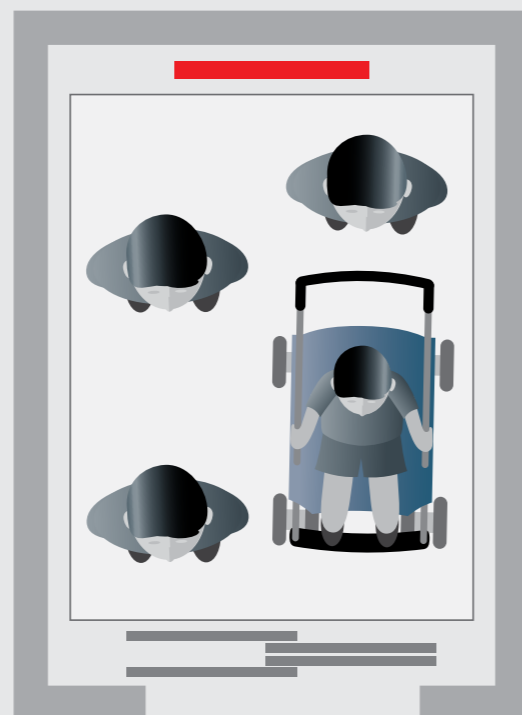

Optimized system to get best usage of shaft and more space in car.

## Driven by flexibility

The new generation Schindler 6200 uses central top suspension and is designed to carry loads of between 180 kg and 630 kg at a nominal speed of 1 m/s. Two alternative drive systems are available to satisfy differing requirements. The existing machine room can be reused where available or, alternatively, the machine can be positioned in the shaft head.



Machine room



Machine room

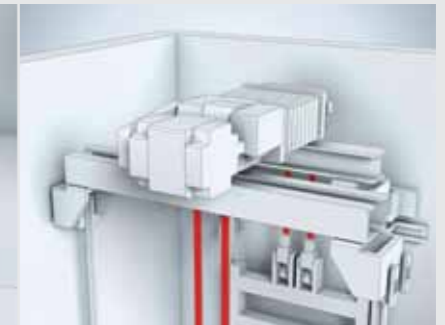

Machine in shaft head

## Open the door to choice

A variety of fully automatic and semi-automatic door systems is available for the new generation Schindler 6200. It can be installed with new box frames or complete metal shaft fronts. Alternatively, the existing swing doors and door frames on each landing can be reused. Various door types are available, including telescopic (T2) and centered (C4) layouts as well as folding car doors, ranging from 600 mm to 900 mm in width. In smaller cars, folding doors open into a niche at the side to create a wider clear entrance.

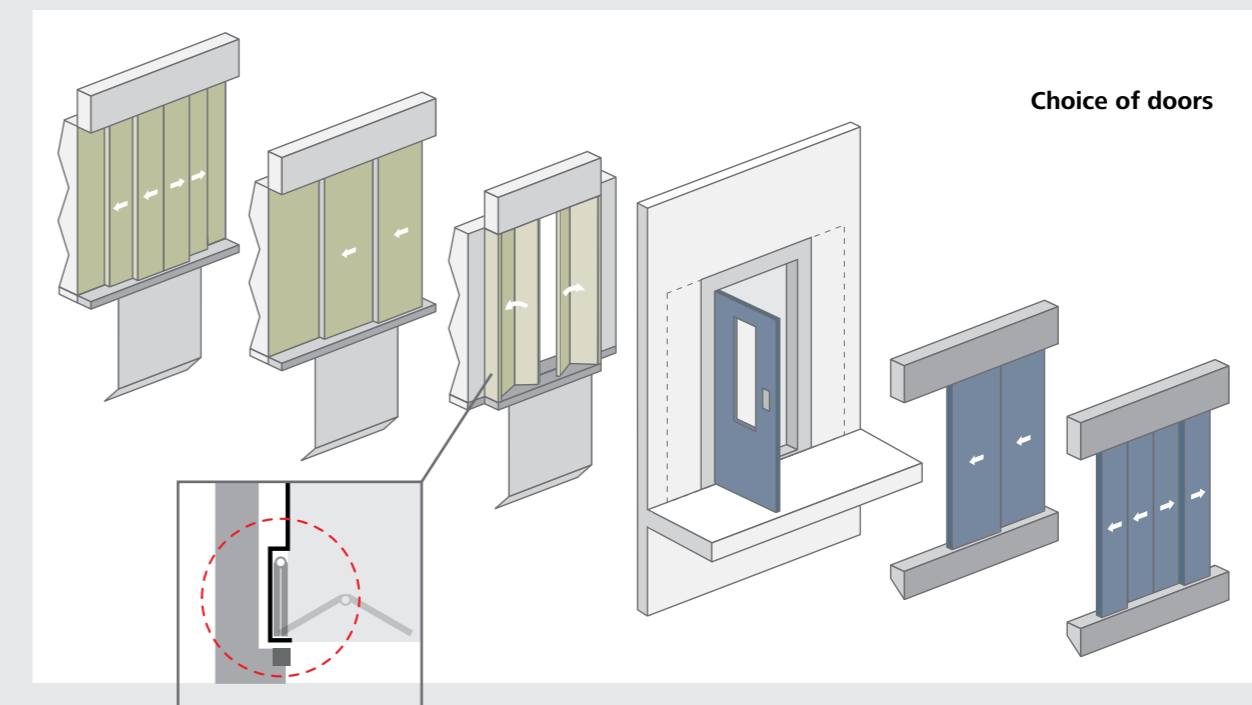

Choice of doors

# Green mobility

The new generation Schindler 6200 is designed to be highly efficient in every aspect: from cost-effective production to optimization of shaft space and energy-efficient performance. So whatever your requirements, you can rest assured it's a sound solution, both economically and ecologically.

## Eco-efficient and energy-saving

Thanks to our Environmental Management System, the Schindler 6200 optimizes your operating costs. Enabled by a perfect interplay of components and a number of ecologically efficient and energy saving features, the new generation Schindler 6200 is a shining example of optimized energy consumption. Its innovative traction media, for instance, weigh less than conventional steel ropes, require less space and therefore consume less energy.

The gearless technology-based drive and ACVF technology further reduce energy consumption, even with optional recycling braking energy and ACVF stand-by. Finally, a series of special features such as LED lamps, automatic switching-off of lighting and ventilation, and electronic stand-by mode for the door drive all make for an outstanding level of energy efficiency.

## Intelligent in design, focused in operation

The energy consumed during the operation of an elevator accounts for three fourths of its lifelong environmental impact. To ensure energy-saving operations, the new generation Schindler 6200 is system engineered, every

single component is ideally matched and the replacement is designed precisely according to the specific mobility needs.



## Energy efficient operation

Superior everyday performance should not be synonymous with higher energy consumption – and with the Schindler 6200 it is not. Thanks to its lightweight system, precision engineering and energy saving features, the Schindler 6200 achieved A classification for energy efficiency according to the VDI4707-1 standard\*.

\* The VDI 4707-1 standard regarding the energy efficiency of lifts is established by the Association of German Engineers (VDI). The VDI 4707-1 standard classes range from "A" to "G", with class "A" being the most energy efficient class. The given result is based on measurements and valid for a Schindler 6200 in VDI usage category 3 with a load of 630 kg, a travel height of 41 m, a speed of 1,0 m/s and with optional energy-saving features (e.g. Recuperating Frequency Converter (PF1) and ACVF stand by). The VDI classification and energy consumption of individual installations may deviate from this result, e.g. due to different or additional customer options and/or different configuration.

## More brainpower. Less environmental impact

Schindler strives to contribute to sustainable and energy-efficient buildings. The new generation Schindler 6200 passenger elevator is a pre-engineered product in which all parts are perfectly adjusted. Over the last decade, Schindler has improved the eco-performance of its products by more than 50%. Ecologically responsible production and material usage, convenient planning, fast installation and trouble-free maintenance make the system perfect.

## Saving energy with innovative drive technology

- Gearless machine for smooth ride quality
- Efficient motor enabling a direct power transfer, avoiding loss of power
- Stable start without high peak current, quickly reaching a low energy consumption level
- Frequency converter optionally equipped with stand-by power mode and braking energy regeneration
- Environmentally friendly as no oil is needed for lubrication
- Compact, lightweight and durable design that optimizes material usage and extends the product's lifespan

## Controlling the efficiency

- Car lights and ventilation are switched into stand-by mode when not in use
- Car panel and floor indicators operate with low power LEDs
- Multi-bus control architecture reduces cabling, material and waste
- Down collective and selective collective controls for efficient passenger transportation

## Optimizing car and shaft usage

- Efficient design creates more car space with same shaft dimensions
- Car lighting equipped with energy saving LED lamps
- Central guiding system reduces mechanical friction and energy consumption
- Door drive optionally with stand-by mode for safety and energy conservation

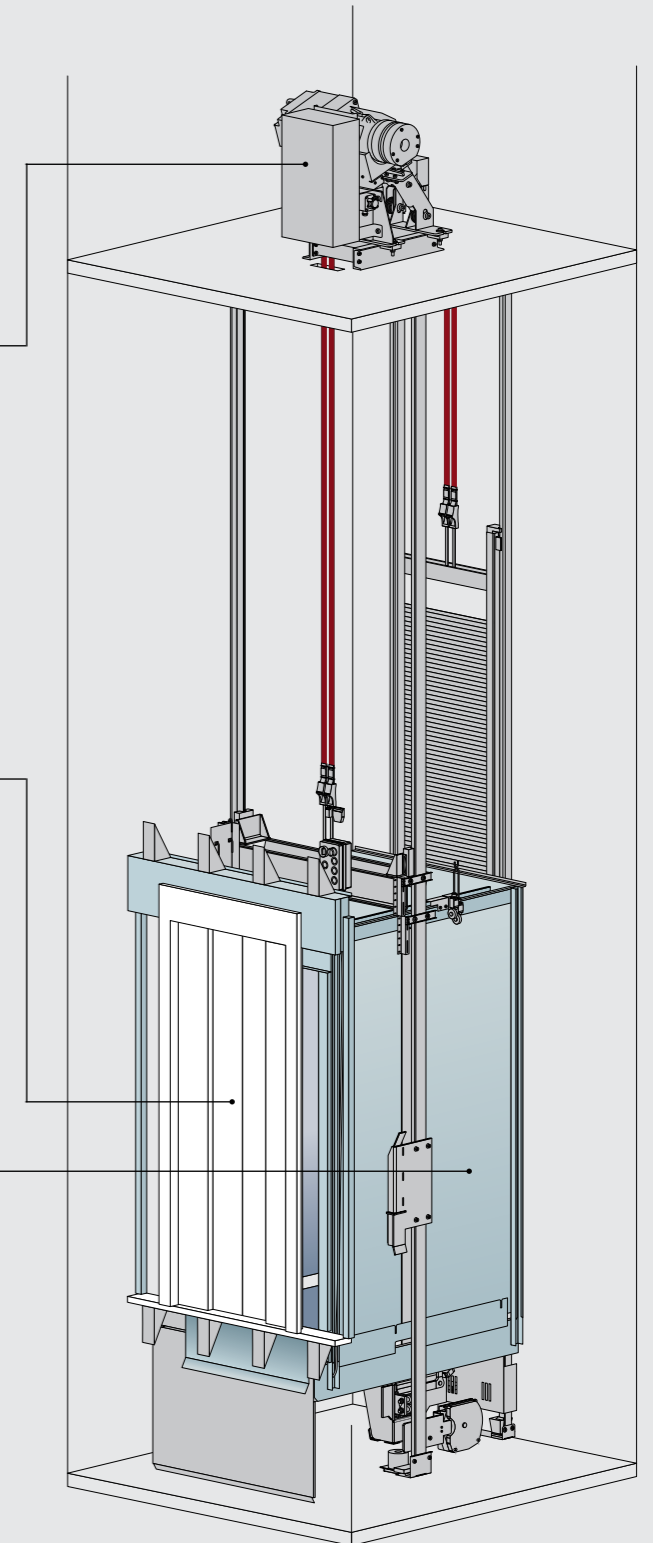

# Delightful design

Create the look and feel you want. Combine colours, materials, lighting, mirrors, handrails and fixtures to achieve the ambiance that fits both your ideas and your building. Choose from one of our four interior design lines or create the car according to your own taste.

## Add personality to your elevator

«Saint Tropez», «Laffitte», «San Marco» and «Park Lane» – our four design lines offer a wide range of decoration options. Choose your design to match your architectural concept and ideas. Provide an unique ride experience with fresh colours, distinctive patterns and high-quality materials.

For detailed information on our four design lines see our separate design lines brochure.

## Saint Tropez

Saint Tropez offers a variety of upbeat and visually striking colours, from bright and breezy to warm and welcoming. Choose one colour for the entire car interior or vary the colours of the rear wall for contrast – an option exclusive to this line.

## Laffitte

Perfect for professional settings, this line's autumnal Northern hues express everyday sophistication. The coloured laminates create a glossy effect and lend the car a distinguished feel.

## San Marco

The San Marco line's naturalistic wood laminate evokes harmony and modernism. Four different styles are at your disposal. Select wood structures, colours, and finishes to create a warm atmosphere in your elevator.

## Park Lane

Captivating stainless steel sets the Park Lane line apart. Six different types of stainless steel are available, from bright brushed to gold, with patterns or without. All are discreetly modern and unassuming.

**Libertà concept**  
If our pre-selected design combinations are not able to cope with your perceptions you can design your own car accordingly.

## Note

Specifications, options and colors are subject to change. All cars and options illustrated in this brochure are representative only. The samples shown may vary from the original in color and material.

Saint Tropez



Laffitte



San Marco



Park Lane



# The perfect outfit with matching accessories

## Operating panels and options

### Outfit your elevator with style

Our operating panels and options, such as handrails, mirrors and lighting, suit your chosen decor to give your elevator the perfect finish – down to the smallest detail.

### Mirrors

Mirrors always add a special sense of space to rooms and buildings. In order to give your car more appeal and depth, one sidewall or the rear wall can be provided with a half or full-height safety glass mirror.

### Handrails

Even though your elevator travels smoothly, handrails convey a feeling of security. Round or straight handrails match the interior and shapes of your car and can be mounted to the side and rear walls.

### Lighting

A selection of different lighting options lets you add the right atmosphere to your elevator – choose between a round and a square style set.

### Operating panels

Make your elevator easy to operate for all passengers. Energy-efficient operating panels all come in high-quality materials and finishings. And to add further elegance to your car interior, you have the option of full-glass fixtures or stainless steel operating panels. Easy-to-read indicators and signs make for a safe and pleasant ride.

For a complete overview of all fixtures and options, see our separate decor lines brochure.



## Stainless steel panel line

Our sleek and wear-resistant combination of stainless steel and glass is equipped with mechanical push buttons. The line consists of car operating panels and landing operating panels as default elements. For clear navigation throughout your building, indicators and nameplates can be supplied.

### Keypad

The keypad features a conventional layout. Each floor is listed separately, ideal for low-rise buildings. Buttons will be arranged in single, double or triple columns, depending on the number of floors.



## Glass panel line

Our stylish and modern glass panel line is equipped with a touch-sensitive keypad. The line consists of car operating panels and landing operating panels as default elements. For clear navigation throughout your building, indicators and nameplates can be supplied.

### Keypads

The glass panel line features two keypad versions for car operating panels. A ten digits layout, allowing passengers to compose the desired floor number (like a phone); and a conventional layout listing each floor (best suited for low rise buildings). Buttons are arranged in triple columns.



Surface mount  
For classic designs



Flush mount  
For a modern, minimalistic look



Styles  
2 Sets

Style  
Straight

Skirtings  
2 Finishings

Skirting  
Stainless steel Brushed

Floors  
8 Colours

Floor  
Artificial granite Black

Walls  
33 Colours

Wall  
Laminate Cadiz Blue



Rear Wall  
Brushed steel  
Doha Gold

Car Door &  
Front  
3 Finishings

Car door & front  
Lausanne Linen

Lighting  
5 Styles

Lighting  
Spot



Handrails  
3 Shapes  
3 Finishings

Handrail straight  
Stainless steel Brushed



Ceilings  
2 Finishings

Ceiling  
Stainless steel Lugano  
Matt





# Libertà – personalize your elevator

Would you like to have different coloured walls or a combination of different styles? With the Libertà concept you can enjoy the possibility to create your own car. Choose the ceiling, add any colour from our décor lines and select your options.

## Walls

Saint Tropez

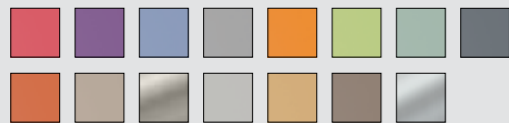

Laffitte

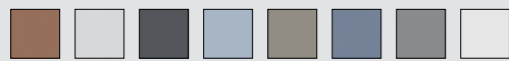

San Marco

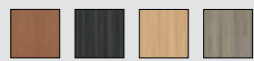

Park Lane



## Mirrors

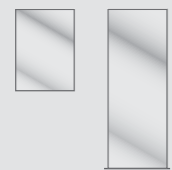

Placement

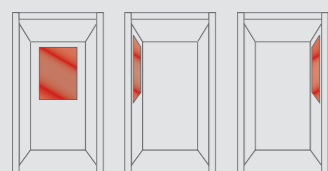

## Floor

Rubber speckled



Artificial granite

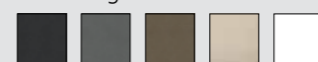

## Ceiling

Stainless steel Lugano Matt Finish

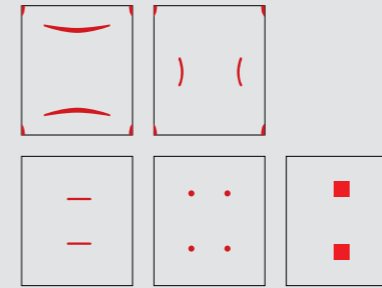

## Operating Panels

Stainless steel, push buttons

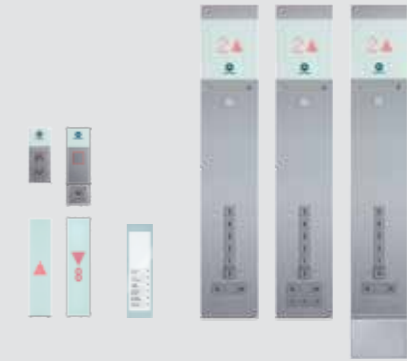

Glass, touch-sensitive

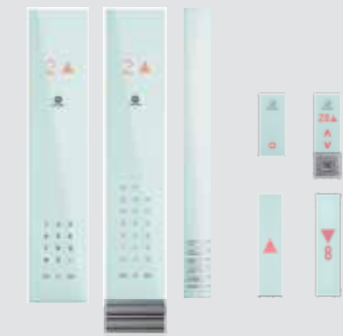

## Handrails

Straight, straight with curved ends or curve & placement

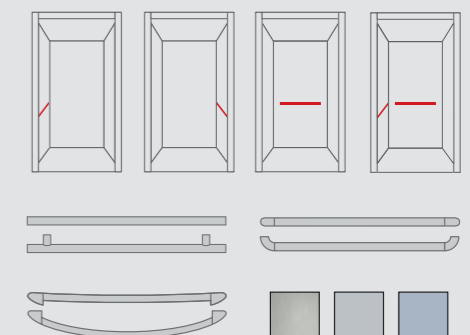

\* available for predefined car widths only

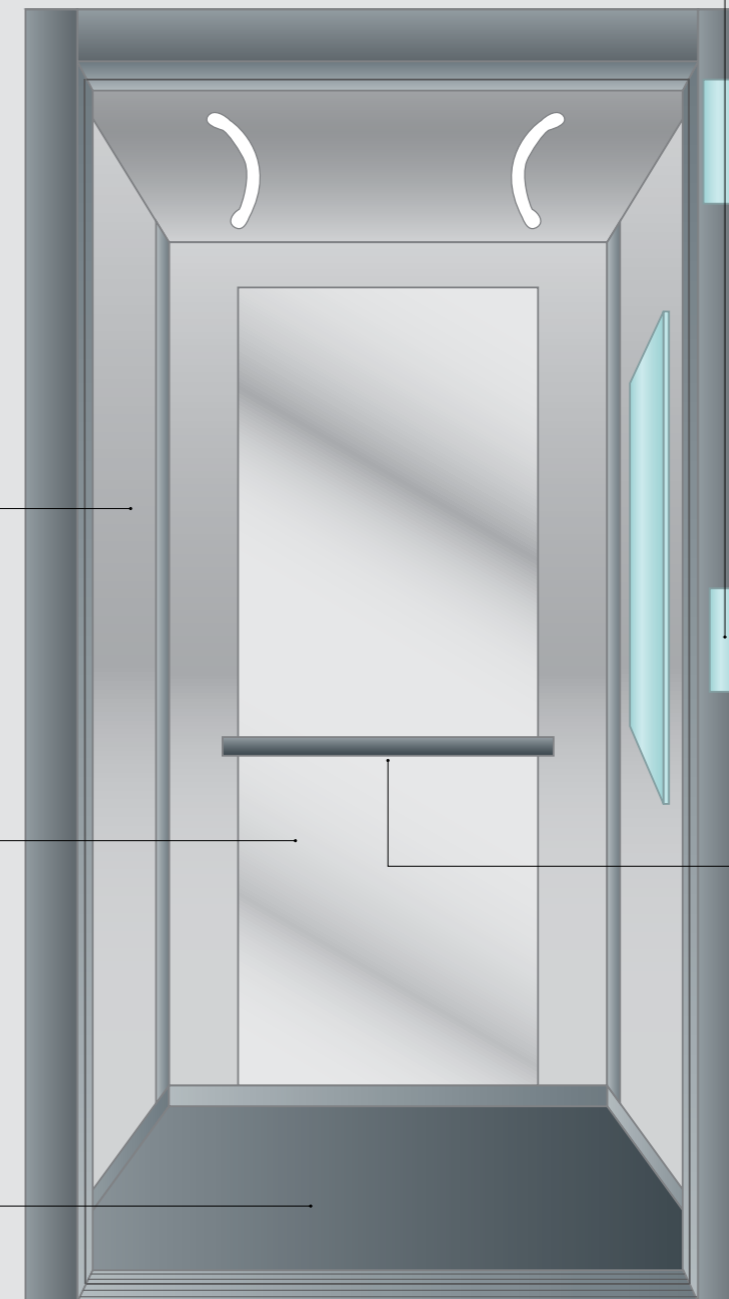

# From the subway to the skyline

## Providing urban mobility

Mobility is an essential requirement in the world in which we live and work. Schindler stands for urban mobility and is recognized as a hallmark of quality and safety. Daily, over one billion people worldwide place their trust in Schindler products and services.



### Trusted company

Dependability since 1874. Schindler provides urban mobility with elevators, escalators and services that are engineered for efficiency and sustainability. Our products are built to last and our expertise is based on:

- Swiss quality engineering
- More than 56'000 dedicated experts
- Network in over 100 countries, available 24/7

### Professional services

Dedicated experts that provide seamless support. Schindler is a reliable partner for the development of buildings from planning and construction to daily operation, thus safeguarding their lifetime value. We understand the challenges of different building types from airports to residential properties. We collaborate with you on:

- Planning & traffic calculations
- Maintenance, Repair & Modernization services
- Customer & Diagnostic services

### Smart solutions

Prepared for the future, made for purpose. Schindler technologies are engineered to optimally serve the requirements of users and buildings. We optimise transit management and service preventively with our maintenance methodologies.

- PORT transit management
- Schindler Direct monitoring & response service
- Schindler Dashboard online portal

# Built-to-last. Always up-to-date.



Modernizing ensures safety, comfort and protects your investment in the long term. Schindler replaces whole systems or step-by-step, by replacing specific parts. Schindler can upgrade any installation to meet passenger needs and to comply with official regulations. Find more information on Schindler products: just scan the code with your mobile phone, using free QR code scanner software. This is pre-installed on your phone or easily downloadable for free.



Schindler Management  
Group Sales & Marketing E1  
Zugerstrasse 13  
6030 Ebikon  
Switzerland

Phone: +41 41 445 31 31  
Fax: +41 41 445 39 11

[www.schindler.com](http://www.schindler.com)

**Schindler Your First Choice.**

This publication is for general informational purposes only and we reserve the right at any time to alter the product design and specifications. No statement contained in this publication shall be construed as a warranty or condition, expressed or implied, as to any product, its fitness for any particular purpose, merchantability, quality or shall be interpreted as a term or condition of any agreement regarding the products or services contained in this publication. Minor differences between printed and actual colours may exist.